

UNCLASSIFIED

U. S. Army Military History Institute

~~SECRET~~

U  
15  
U635  
no. 22  
c. 2

CIAL SERIES, NO. 22

31 MARCH 1944

COMPANY OFFICER'S  
HANDBOOK  
OF THE  
GERMAN ARMY

UNCLASSIFIED

REGRADED \_\_\_\_\_ BY AUTHORITY

OF E.O. 10501

BY RAKERS ON 12 Aug 87

PREPARED BY  
MILITARY INTELLIGENCE DIVISION  
WAR DEPARTMENT

~~SECRET~~

PROPERTY OF US ARMY

UNCLASSIFIED

UNCLASSIFIED

  
MILITARY INTELLIGENCE DIVISION  
WAR DEPARTMENT  
WASHINGTON 25, D. C., 31 March 1944

SPECIAL SERIES  
No. 22  
MID 461

## NOTICE

1. *Special Series* is published for the purpose of providing officers with reasonably confirmed information from official and other reliable sources.
2. By arrangement with The Adjutant General the following three publications of the Military Intelligence Division are distributed in the same manner as prescribed for field manuals (see FM 21-6, *List of Publications for Training*, pars. 6-9, 23a):

*Intelligence Bulletin* (commencing with March 1944 issue);

*Special Series* (commencing with No. 20);

*Tactical and Technical Trends* (commencing with March 1944 issue).

Requests for copies of these publications should be made to the appropriate distributing agency of The Adjutant General. Requests for issues prior to those listed above should be forwarded through channels to the MID address below.

3. Initial distribution of this issue of *Special Series* is being made, except in Asiatic and Pacific areas, on the basis of two copies to each company and higher headquarters. Every command should circulate available copies among its officers.
4. Reproduction within the military service is permitted provided that (1) the source is stated, (2) the classification is maintained, and (3) one copy of the publication in which the material is reproduced is forwarded to the **Dissemination Unit, Military Intelligence Division, War Department, Washington 25, D. C.**

  
UNCLASSIFIED

## CONTENTS

	Page
<b>Section I. OFFENSIVE PRINCIPLES</b> .....	1
1. ATTACK .....	1
2. INFANTRY AND TANKS .....	5
3. TOWN AND STREET FIGHTING .....	7
4. RECONNAISSANCE .....	9
a. General .....	9
b. Armored Reconnaissance .....	10
5. PATROLS .....	11
6. MEETING ENGAGEMENT .....	12
7. DEPLOYMENT .....	13
<b>II. DEFENSIVE PRINCIPLES</b> .....	16
8. GENERAL .....	16
9. TANKS IN DEFENSE .....	17
10. DEFENSE OF TOWNS .....	18
11. ORGANIZATION OF A DEFENSIVE POSITION.....	19
a. Covering Position.....	19
b. Outpost Position.....	20
c. Main Defensive Position.....	21
<b>III. EMPLOYMENT OF SUPPORT WEAPONS</b> .....	25
12. MACHINE GUNS .....	25
13. INFANTRY HOWITZERS AND MORTARS.....	26
a. Infantry Howitzers .....	26
b. Mortars .....	27
14. ROCKET PROJECTORS .....	28
<b>IV. WEAPONS, OBSTACLES, AND VEHICLES</b> .....	29
15. RIFLES AND CARBINES.....	29
a. General .....	29
b. Ammunition .....	30
c. Grenade Launchers.....	31
16. PISTOLS .....	31
17. SUBMACHINE GUNS .....	31
18. GRENADES .....	34
a. General .....	34
b. Use .....	37
19. MACHINE GUNS .....	37
20. INFANTRY MORTARS.....	41
21. INFANTRY HOWITZERS.....	43

**Section IV. WEAPONS, OBSTACLES, AND VEHICLES—Continued.**

	Page
22. ANTITANK WEAPONS .....	45
a. Normal Weapons .....	45
b. Special and Miscellaneous Weapons .....	50
23. HEAVY CHEMICAL MORTARS AND ROCKET WEAPONS .....	50
24. ARTILLERY .....	52
a. General .....	52
b. Division Artillery .....	53
c. GHQ Reserve Artillery .....	57
d. Antiaircraft Guns .....	57
25. OBSTACLES, LAND MINES, AND BOOBY TRAPS .....	58
a. General .....	58
b. Land Mines .....	61
c. Booby Traps .....	63
26. ARMORED VEHICLES AND SELF-PROPELLED GUNS .....	63
a. Tanks .....	63
b. Armored Cars and Half-tracks .....	67
c. Self-propelled Weapons .....	67
<b>V. COMBAT TEAMS .....</b>	<b>70</b>
27. GENERAL .....	70
28. COMBAT TEAMS IN SICILY .....	71
29. COMBAT TEAMS IN ITALY .....	75
a. General .....	75
b. Combat Team Viebig .....	76
c. Combat Team Heilmann .....	76
d. Combat Team Rau .....	77
<b>VI. ORGANIZATION DATA .....</b>	<b>78</b>
30. INFANTRY DIVISION: REORGANIZATION TREND .....	78
31. INFANTRY DIVISION: TABLES OF ORGANIZATION .....	79
a. Infantry Division ( <i>Infanteriedivision</i> ): Organization Chart .....	79
b. Infantry Division ( <i>Infanteriedivision</i> ): Strength and Weapons .....	80
c. Reconnaissance Battalion ( <i>Aufklärungsabteilung</i> ): Organization Chart (Inf Div) .....	81
d. Reconnaissance Battalion ( <i>Aufklärungsabteilung</i> ): Strength and Weapons (Inf Div) .....	82
e. Infantry Regiment ( <i>Grenadierregiment</i> ): Organiza- tion Chart (Inf Div) .....	83
f. Infantry Regiment ( <i>Grenadierregiment</i> ): Strength and Weapons (Inf Div) .....	84
g. Rifle Company ( <i>Grenadierkompanie</i> ): Organization Chart (Inf Div) .....	85
h. Artillery Regiment ( <i>Artillerieregiment</i> ): Organization Chart (Inf Div) .....	86

## Section VI. ORGANIZATION DATA—Continued.

	Page
i. Antitank Battalion ( <i>Panzerjägerabteilung</i> ): Organization Chart (Inf Div).....	87
j. Artillery Regiment ( <i>Artillerieregiment</i> ): Strength and Weapons (Inf Div).....	88
k. Antitank Battalion ( <i>Panzerjägerabteilung</i> ): Strength and Weapons (Inf Div).....	88
32. ARMORED (PANZER) DIVISION: REORGANIZATION TREND.....	89
33. ARMORED (PANZER) DIVISION: TABLES OF ORGANIZATION.....	90
a. Armored Division ( <i>Panzerdivision</i> ): Organization Chart .....	90
b. Armored Division ( <i>Panzerdivision</i> ): Strength and Weapons .....	91
c. Armored Reconnaissance Battalion ( <i>Panzeraufklär-     ungsabteilung</i> ): Organization Chart (Armd Div)....	92
d. Armored Reconnaissance Battalion ( <i>Panzeraufklär-     ungsabteilung</i> ): Strength and Weapons (Armd Div)....	93
e. Tank Regiment ( <i>Panzerregiment</i> ): Organization Chart (Armd Div) .....	94
f. Tank Regiment ( <i>Panzerregiment</i> ): Strength and Weapons (Armd Div).....	95
g. Tank Company ( <i>Panzerkompanie</i> ) (with <i>Pz.Kpfw.     III</i> or <i>IV</i> tanks); Organization Chart (Armd Div)....	96
h. Tank Company ( <i>Panzerkompanie</i> ) (with <i>Pz.Kpfw.     III</i> tanks): Strength and Weapons (Armd Div)....	96
i. Tank Company ( <i>Panzerkompanie</i> ) (with <i>Pz.Kpfw.     IV</i> , <i>Panther</i> , or <i>Tiger</i> tanks): Strength and Weapons (Armd Div).....	97
j. Panzer-Grenadier Regiment ( <i>Panzergrenadierregi-     ment</i> ): Organization Chart (Armd Div).....	98
k. Panzer-Grenadier Regiment ( <i>Panzergrenadierregi-     ment</i> ): Strength and Weapons (Armd Div).....	99
l. Panzer-Grenadier Company (Motorized) ( <i>Panzergren-     adierkompanie</i> ): Organization Chart (Armd Div)....	100
m. Panzer-Grenadier Company (Motorized) ( <i>Panzergren-     adierkompanie</i> ): Strength and Weapons (Armd Div)....	101
n. Panzer-Grenadier Platoon (Motorized) ( <i>Panzergren-     adierzug</i> ): Strength and Weapons (Armd Div).....	101
o. Machine-gun Platoon (Motorized) ( <i>schwerer Zug</i> ): Strength and Weapons (Armd Div).....	101
p. Panzer-Grenadier Company (Armored) ( <i>Panzergren-     adierkompanie (gep)</i> ): Organization Chart (Armd Div) .....	102

**Section VI. ORGANIZATION DATA—Continued.**

	Page
q. Panzer-Grenadier Company (Armored) ( <i>Panzergrenadierkompanie (gep)</i> ): Strength and Weapons (Armd Div).....	103
r. Panzer-Grenadier Platoon (Armored) ( <i>Panzergrenadierzug (gep)</i> ): Strength and Weapons (Armd Div).....	103
s. Machine-gun Platoon (Armored) ( <i>schwerer Zug (gep)</i> ): Strength and Weapons (Armd Div).....	104
t. Heavy-Weapons Company ( <i>schwere Kompanie</i> ): Organization Chart (Armd Div).....	104
u. Heavy-Weapons Company (Motorized) ( <i>schwere Kompanie</i> ): Strength and Weapons (Armd Div)....	105
v. Heavy-Weapons Company (Armored) ( <i>schwere Kompanie (gep)</i> ): Strength and Weapons (Armd Div).....	105
w. Armored Artillery Regiment ( <i>Panzerartillerieregiment</i> ): Organization Chart (Armd Div).....	106
x. Armored Artillery Regiment ( <i>Panzerartillerieregiment</i> ): Strength and Weapons (Armd Div).....	107
<b>34. MOTORIZED DIVISION: TABLES OF ORGANIZATION.....</b>	<b>108</b>
a. Motorized Division ( <i>Panzergrenadierdivision</i> ): Organization Chart.....	108
b. Motorized Division ( <i>Panzergrenadierdivision</i> ): Strength and Weapons.....	109
<b>35. LIGHT DIVISION: TABLES OF ORGANIZATION.....</b>	<b>110</b>
a. Light Division ( <i>Jägerdivision</i> ): Organization Chart....	110
b. Light Division ( <i>Jägerdivision</i> ): Strength and Weapons.....	111
<b>36. MOUNTAIN DIVISION: TABLES OF ORGANIZATION.....</b>	<b>112</b>
a. Mountain Division ( <i>Gebirgsdivision</i> ): Organization Chart.....	112
b. Mountain Division ( <i>Gebirgsdivision</i> ): Strength and Weapons.....	113
<b>37. GHQ 120-MM MORTAR BATTALION: TABLES OF ORGANIZATION.....</b>	<b>114</b>
a. 120-mm Mortar Battalion ( <i>schwere Granatwerferabteilung</i> ): Organization Chart.....	114
b. 120-mm Mortar Battalion ( <i>schwere Granatwerferabteilung</i> ): Strength and Weapons.....	114
<b>38. GHQ HEAVY TANK BATTALION: TABLES OF ORGANIZATION.....</b>	<b>115</b>
a. Heavy Tank Battalion ( <i>schwere Panzerabteilung</i> ): Organization Chart.....	115
b. Heavy Tank Battalion ( <i>schwere Panzerabteilung</i> ): Strength and Weapons.....	116
<b>39. GHQ ANTITANK BATTALION: TABLES OF ORGANIZATION.....</b>	<b>117</b>
a. Antitank Battalion ( <i>Panzerjägerabteilung Tiger-P</i> ): Organization Chart.....	117

## CONTENTS

vii

### Section VI. ORGANIZATION DATA—Continued.

	Page
b. Antitank Battalion ( <i>Panzerjägerabteilung Tiger-P</i> ): Strength and Weapons.....	118
40. GHQ CHEMICAL (SMOKE) REGIMENTS: ORGANIZATION CHARTS .....	119
a. Chemical (Smoke) Regiment ( <i>(Nebel) Werferregiment</i> ) (with 105-mm Smoke Mortars or 150-mm Rocket Projectors).....	119
b. Heavy Chemical (Smoke) Regiment ( <i>(schweres (Nebel) Werferregiment</i> ) (with 150-mm Rocket Projectors).....	120
<b>VII. MILITARY SYMBOLS</b> .....	121
41. GENERAL .....	121
42. BASIC SYMBOLS FOR HEADQUARTERS .....	121
43. BASIC SYMBOLS FOR BRANCHES OF SERVICE .....	122
44. BASIC SYMBOLS FOR WEAPONS AND EQUIPMENT .....	123
45. INDICATION OF UNITS .....	124
46. SUPPLEMENTARY SYMBOLS .....	125
47. SUPPLEMENTARY ABBREVIATIONS .....	127
48. SUPPLEMENTARY NUMERALS .....	127
49. COMPOSITE UNITS .....	129
50. EXAMPLE OF A DIAGRAMMATIC TABLE OF ORGANIZATION .....	129
51. SUPERSEDED WEAPON AND EQUIPMENT SYMBOLS .....	130

## ILLUSTRATIONS

Figure	Page
1. German enveloping tactics.....	1
2. German <i>Schwerpunkt</i> : frontages and objective.....	3
3. German infantry firing automatic weapons .....	4
4. Panzer grenadiers going into combat direct from armored personnel carriers .....	6
5. Attack on a town.....	8
6. Reconnaissance patrol of an SS division.....	10
7. Deployment of a German infantry regiment: ① first stage (deployment by battalions); ② second stage (deployment in detail).....	14
8. German company in a defensive position.....	22
9. Side view of the standard German rifle ( <i>Karabiner 98K</i> ), showing grenade- launching attachments.....	29
10. Top view of the standard German rifle ( <i>Karabiner 98K</i> ).....	29
11. Characteristics of the standard German rifle ( <i>Karabiner 98K</i> ).....	30
12. Identification marks of German 7.92-mm small-arms ammunition.....	31
13. Luger pistol ( <i>Pistole 08</i> ) and magazine.....	32
14. Walther pistol ( <i>Pistole 38</i> ) and magazine.....	32
15. Characteristics of Luger and Walther pistols.....	33
16. Two views of the <i>M.P. 40</i> , showing skeleton shoulder stock folded (above), and open (below).....	34

Figure	Page
17. Characteristics of the <i>M.P. 38</i> and <i>M.P. 40</i> .....	35
18. Stick-type hand grenade, model 24 .....	35
19. Characteristics of common grenades .....	36
20. Two views of the <i>M.G. 34</i> on bipod mount .....	37
21. Characteristics of the <i>M.G. 34</i> and <i>M.G. 42</i> .....	38
22. <i>M.G. 42</i> on bipod mount .....	39
23. <i>M.G. 34</i> on tripod mount .....	39
24. Characteristics of the 50-mm and 81-mm infantry mortars .....	40
25. 50-mm mortar, model 36 .....	41
26. 81-mm mortar, model 34 .....	42
27. 75-mm (light) and 150-mm (heavy) infantry howitzers (from left to right) .....	43
28. Characteristics of the 75-mm and 150-mm infantry howitzers .....	44
29. 75-mm, 50-mm, and 37-mm antitank guns (from left to right) .....	45
30. Front view of the 88-mm antitank gun ( <i>8.8 cm Pak 43</i> ) .....	46
31. Rear view of the 88-mm antitank gun ( <i>8.8 cm Pak 43</i> ) .....	46
32a. Characteristics of common antitank weapons .....	47
32b. Characteristics of special and miscellaneous German and captured anti- tank weapons .....	48
33. Antitank rifle ( <i>Pz.B. 39</i> ) .....	49
34. 28/20-mm antitank gun ( <i>s.Pz.B. 41</i> ) .....	49
35. 150-mm six-barreled rocket projector ( <i>15 cm Nebelwerfer 41</i> ) .....	51
36. 150-mm ten-barreled rocket projector ( <i>15 cm Panzerwerfer 42</i> ) in action....	51
37. 105-mm howitzer ( <i>10.5 cm le.F.H. 18</i> ) .....	53
38. 105-mm gun ( <i>10.5 cm K. 18</i> ) .....	54
39. 150-mm howitzer ( <i>15 cm s.F.H. 18</i> ) .....	54
40. Characteristics of standard artillery weapons of the division artillery regi- ment .....	55
41. 170-mm gun ( <i>17 cm Kanone in Mörser-Lafette 18</i> ) .....	56
42. 210-mm howitzer ( <i>21 cm Mörser 18</i> ) .....	57
43. 20-mm dual-purpose gun ( <i>2 cm Flak 38</i> ) .....	59
44. 88-mm dual-purpose gun ( <i>8.8 cm Flak 18</i> ) .....	59
45. Characteristics of common antiaircraft guns .....	60
46. Antitank mine ( <i>Tellermine 43</i> ) .....	61
47. Antipersonnel mine ( <i>Schrapnellmine</i> ): ① laid with pressure igniter; ② laid with pull igniter and trip wires .....	62
48. <i>Pz.Kpfw. I</i> .....	64
49. <i>Pz.Kpfw. II</i> .....	64
50. <i>Pz.Kpfw. III</i> (with 50-mm long-barreled tank gun) .....	65
51. <i>Pz.Kpfw. IV</i> (with 75-mm long-barreled tank gun) .....	65
52. <i>Pz.Kpfw. Panther</i> .....	66
53. <i>Pz.Kpfw. Tiger</i> .....	66
54. Armor skirting on a <i>Pz.Kpfw. IV</i> (with 75-mm short-barreled tank gun) .....	67
55. Eight-wheeled armored car (with 75-mm short-barreled tank gun) .....	68
56. 75-mm assault gun ( <i>7.5 cm Sturmkanone, or Stu.K., 40</i> ) .....	69



CONTENTS

IX

Figure	Page
57. 88-mm self-propelled antitank gun ( <i>Pz. Jäg. Tiger-P (Ferdinand)</i> ).....	69
58. Combat teams based on the Hermann Göring Panzer Division (as of 16 July 1943).....	73
59. Combat teams based on the Hermann Göring Panzer Division (as of 21 July 1943).....	74



# Section I. OFFENSIVE PRINCIPLES

## 1. ATTACK

In the attack the Germans stress the principle that the enemy must be surrounded and destroyed. They believe that a strong, rapid enveloping attack can be decisive, provided that it really comes to grips with the enemy while he is pinned down by frontal pressure, which the Germans exert mainly by fire. The enveloping forces advance in depth in order to avoid being outflanked, the guiding principle being that all enveloping attacks ultimately become frontal. (See fig. 1.)

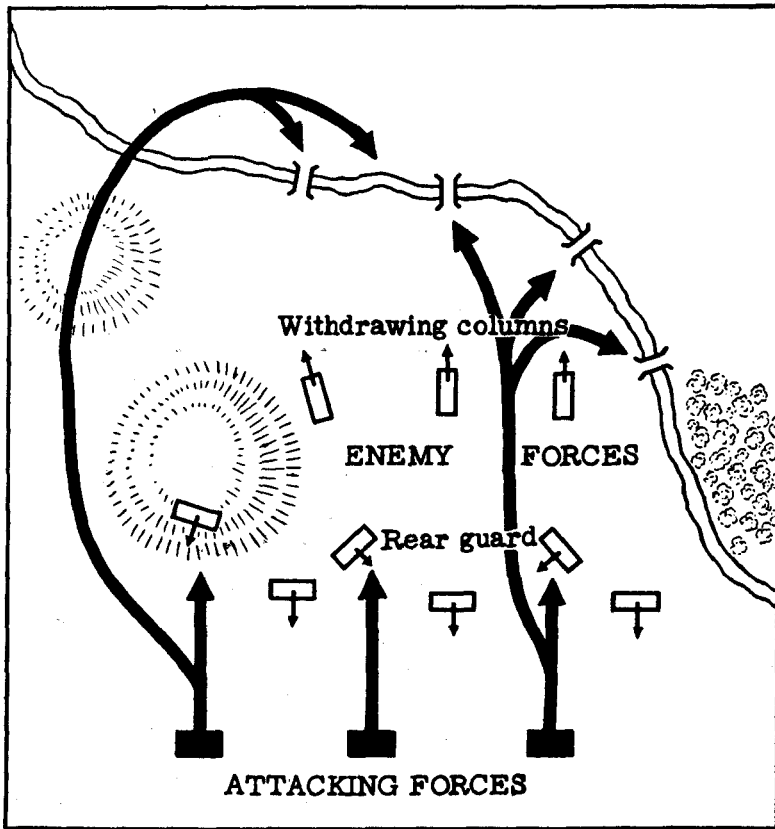

Figure 1.—German enveloping tactics.

In all attacks a German commander will select a point of main effort (*Schwerpunkt*), where he will employ the bulk of his forces in order to force a decision. (See fig. 2.) A German maxim is—"A commander without a *Schwerpunkt* is like a man without character." In selecting the point of main effort the Germans consider the following factors:

- (a) Weaknesses in the enemy's defensive position.
- (b) Suitability of the terrain, especially for tanks, and for cooperation of all arms.
- (c) Approach routes.
- (d) Possibilities for supporting fire, especially by artillery.

The Germans allot sectors and objectives to attacking units, but this does not mean that a unit must cover with troops the whole ground within its boundaries. The unit will choose the best line or lines of advance within its area and dispose its troops accordingly. The battalion making the assault at the point of main effort may be allotted a front of about 450 yards, while a battalion in another area may be assigned a front of 1,000 yards or more. In actual practice, unit frontages may vary considerably. During the Tunisian Campaign, General Jürgen von Arnim, the German commander, stated that 1½ battalions might well attack on a front of 2,000 yards.

An attack on a narrow front, according to German doctrine, must have sufficient forces at its disposal to widen a penetration, maintain its impetus, and protect the flanks of the penetration. Once it is launched, the attack must drive straight to its objective, regardless of opposition. The Germans maintain that it is wrong for the foremost elements of the attacking forces to turn aside to deal with threats to their flanks. This is a task which is assigned to the troops that follow.

An effort is made by the Germans to push a break-through sufficiently deep to prevent the enemy from establishing new positions in the rear. The attacking forces attempt to reduce individual enemy positions by encircling and isolating them. They do not consider a break-through successful until they capture the enemy's artillery positions; usually this is the special task of tanks. Where enemy resistance weakens at any point, all available fire and forces are concentrated to ensure the success of the break-through. The artillery is kept well forward.

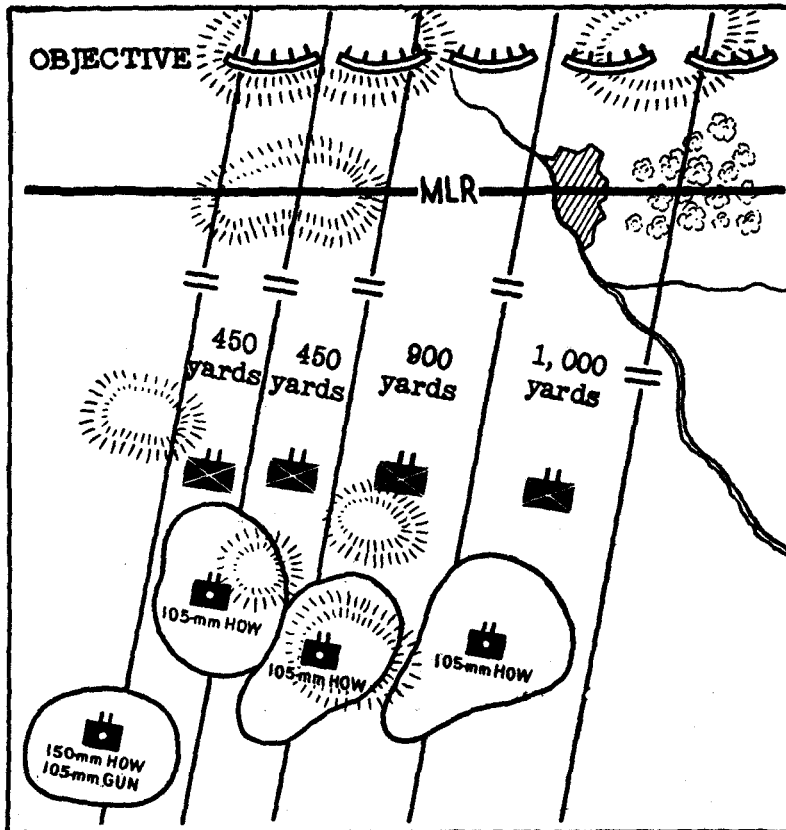

Figure 2.—German Schwerpunkt: frontages and objective.

The Germans regard their self-propelled assault guns as decisive weapons which are employed particularly at the point of main effort. In cooperation with infantry, they facilitate the penetration and break-through with a minimum of casualties. These weapons, the Germans believe, complement artillery fire by their ability to follow the infantry right up to an objective. Their use for small actions before an attack is forbidden so as not to betray their presence. Surprise is sought by bringing them into position by night and camouflaging their assembly area. Used primarily to neutralize enemy support weapons at short ranges over open sights, assault guns are employed in concentrations; to employ them singly or in comparatively small number is frowned upon by the Germans.

German assault guns advance with or just behind the infantry;

they never go ahead of the infantry. When an objective is reached, the assault guns do not remain with the infantry while the position is being consolidated but retire about 1,000 yards to await further assignment. It is a German principle that assault guns must always have close protection from the infantry which they are supporting.

Other characteristic features of German tactics in the attack are as follows:

- (a) Some of the motorized supporting weapons are held back to exploit a success, to support a further advance, or to build up strength at the point of main effort.
- (b) Smoke is used liberally, particularly to screen the flanks of an attacking force.
- (c) Assault detachments, including engineers equipped with explosive charges and flame throwers, are used against strongly prepared defensive positions. Fire support for such detachments is heavy and carefully planned.
- (d) Antitank guns of all calibers are employed, sometimes singly, against fixed positions and concrete emplacements.
- (e) Small groups of riflemen with automatic weapons will infiltrate enemy positions and work around the flanks and rear of an enemy force in an effort to give the impression that it is surrounded. (See fig. 3.) In open warfare, reconnaissance

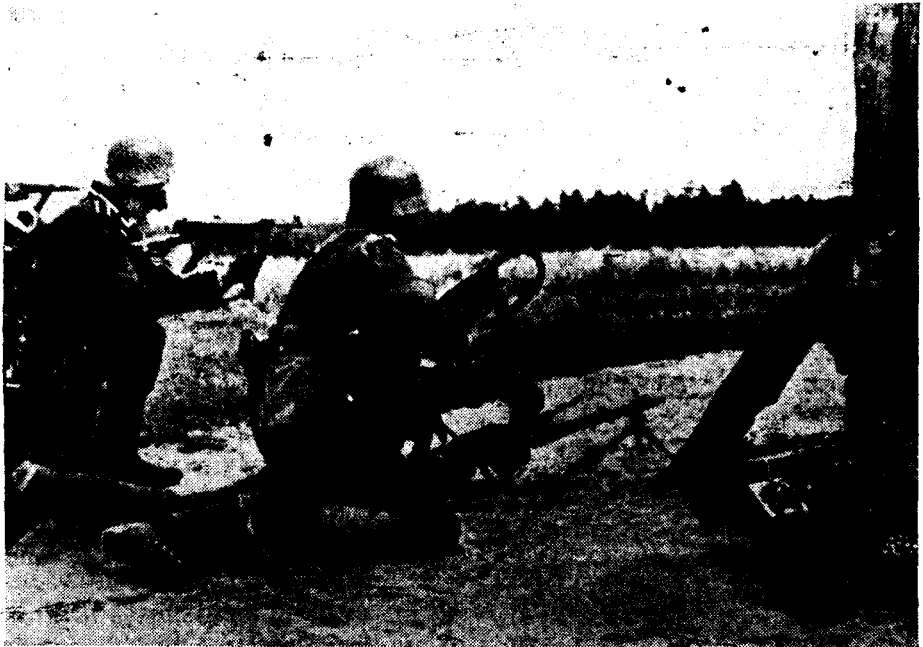

**Figure 3.**—German infantry firing automatic weapons. (The soldier at the left is the sergeant commanding a squad of which the light machine gun is part. Firing next to him is the lieutenant leading the platoon. Under cover of the house is number 2 of the crew, with ammunition box in front of him.)

details may be used for this purpose. Small groups may also infiltrate a position at night and open fire from the rear at dawn as a preliminary to an attack. Thus they attempt to cause confusion and to create the impression that the defenders are surrounded.

(f) Tanks tow or carry heavily armed infantry and engineers into combat in order to organize and hold positions in captured terrain, or to neutralize antitank defenses. Tanks may also be used to tow antitank guns.

## 2. INFANTRY AND TANKS

Usually German tanks do not operate independently, but are employed in combat teams in cooperation with infantry, field and anti-tank artillery, and engineers. In the operations of armored divisions, tank units and panzer grenadiers (armored infantry) are combined and fight as a unified force. In an infantry-tank attack the Germans transport the infantry into battle on tanks or in troop-carrying vehicles in order to protect the infantry and to increase its speed. The infantry leaves the vehicles at the last possible moment, and goes into action mainly with light automatic weapons.

Before making a decision on the respective tasks of infantry and armored units, the commander of a combined force employs reconnaissance elements which differ from those used by an infantry commander in that they have greater fire power, speed, and mobility; he uses more armored cars and motorcycles, and supports them with a few tanks when necessary.

The Germans usually form combat teams of all arms whenever rapid deployment for a meeting engagement is expected. An advance guard consisting of panzer grenadiers, tanks, and antitank weapons moves ahead as a screen to cover the deployment of a combat team. If the terrain over which the attack is to be made is a natural tank obstacle, or if it is protected by antitank mine fields and ditches covered by fire, detachments of motorized infantry and engineers, perhaps with tank support, will clear a path for the main body of tanks.

In open country the Germans are prone to attack hard and fast in order to capture a commanding feature, which, because of its tactical importance, the enemy cannot afford to lose, thus compelling the enemy to counterattack at all costs. Once in possession of the feature, strong supporting artillery (including antitank and

antiaircraft-antitank weapons) occupies forward positions, and the tanks withdraw to the rear of the artillery. Enemy armored vehicles and troops which may counterattack are then confronted at once by a strong artillery screen.

The Germans generally avoid tank-versus-tank actions, and adhere to the principle that the task of the tanks is to break through and help to destroy infantry, not necessarily to seek out and destroy enemy tanks. Destruction of tanks is a mission assigned mainly to antitank units.

The Germans stress the need for the concentrated employment of the whole available tank force, except necessary reserves, at the decisive place and time. The tank force will try to penetrate to the enemy's lines of communication, and the infantry will mop up. The attack normally proceeds in three waves. The first wave thrusts to the enemy's artillery positions. The second wave provides covering fire for the first wave, and then attacks the enemy's infantry position, preceded, accompanied, or followed by part of the panzer



Figure 4.—Panzer grenadiers going into combat direct from armored personnel carriers. (The near half-track vehicle mounts a light machine gun; the far one, a 37-mm antitank gun.)



grenadiers, who dismount from their combat vehicles as close as possible to the point where they must engage the enemy. (See fig. 4.) The objectives of the second wave are the enemy's antitank defenses and infantry positions, which are attacked with high-explosive and machine-gun fire. The third wave, accompanied by the remainder of the panzer grenadiers, mops up.

The introduction of the heavy tank (*Pz.Kpfw. Tiger*) has led to a modification of German tactics, and reports from the Eastern Front indicate that *Tiger* tanks were sometimes used there in an independent role. The *Tiger* tank has been employed mainly to provide support for light and medium tanks. In one action in the Tunisian Campaign, however, lighter tanks formed the spearhead of an attack, but when Allied tanks came within range, the lighter German tanks deployed to the flanks and the *Tiger* tanks engaged.

In one attack in Russia, *Tiger* tanks were reported to have been used to obtain a battering-ram effect in an attack in the Byelgorod-Orel sector. A force of 20 to 30 *Tiger* tanks led the attack, followed by 40 to 60 self-propelled guns. Behind the guns were German light and medium tanks and some Czech light tanks used as mounts for guns of approximately 75-mm caliber. German light and medium tanks were also used to cover the flanks.

### 3. TOWN AND STREET FIGHTING

In attacking a town or village, the Germans will employ flanking and encircling tactics (see fig. 5, p. 8); one of their primary missions is to cut off water, electricity, and gas supplies. While carrying out the flanking maneuver, the Germans will endeavor to pin down the defenders with heavy artillery fire.

If a direct assault must be made on the town, the Germans favor laying heavy supporting fire on the forward edge of the community, especially on detached groups of buildings and isolated houses. The assaulting troops most likely will be divided into a number of columns and make a series of coordinated parallel attacks. Attacks from opposite directions and conflicting angles are avoided on the ground that they lead to confusion and to firing on friendly troops.

The columns will be subdivided into assault groups and mop-up groups. Assault detachments of engineers equipped with demolition

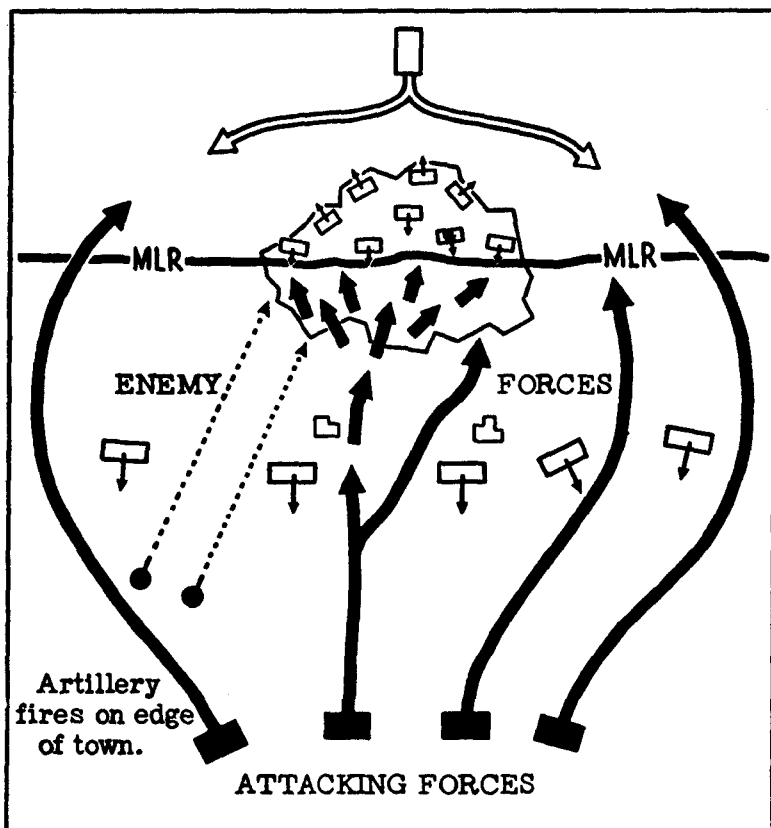

Figure 5.—Attack on a town.

equipment, flame throwers, and grenades, may accompany the infantry. The advance through the town is likely to be made in bounds measured in terms of one or a few streets; after each bound the troops re-form and proceed to new objectives. The Germans avoid the streets as much as possible and infiltrate simultaneously through back yards and over roofs, attempting to seize all high ground.

If it is necessary for them to advance through streets, the Germans move in two files, one on each side of the thoroughfare. The left side is preferred, as it is more advantageous for firing right-handed from doorways. Consideration is given to the problem of fighting against defenders organized not only in depth but also in height. Consequently the men, from front to rear, will be given

specific assignments to watch the roofs, the various floors of buildings, and cellar windows. Side streets are blocked immediately, and at night searchlights are kept ready to illuminate roofs. The Germans endeavor to keep constant contact with the artillery, and single light guns may accompany the infantry in order to engage points of resistance with direct fire. Extensive use also is made of rocket weapons and mortars.

When a section of a town is captured, the Germans close up all side streets leading from the occupied area, block all exits of houses, and then begin a house-to-house search with details assigned to specific tasks, such as mopping up roofs, attics, basements, courtyards, and staircases. Cellars and attics are occupied first in organizing for defense.

## **4. RECONNAISSANCE**

### **a. General**

In the German Army, normal reconnaissance is carried out by the division reconnaissance battalion. Reconnaissance patrols are likely to be mixed, and may include cyclists, motorcyclists, cavalry, or armored cars, depending on the type of division, and may be strongly reinforced with mobile close-support and antitank weapons to enable them to cope with special situations. A relatively large number of antitank guns, which are likely to be self-propelled, are allotted to reconnaissance forces; this is also true of advance guards, in which the antitank guns are placed well forward.

The importance of reconnaissance was stressed by General Jürgen von Arnim, the German commander in the Tunisian Campaign, in a general order. He said: "For correct handling of troops it is indispensable to know about the enemy. If one does not, one runs blindly into enemy fire. Therefore—reconnaissance and again reconnaissance! It must be carried out by sectors, from ridge to ridge (including reconnaissance of future artillery observation posts), in exactly the same way as the attack—to ensure that the supporting weapons follow up in time."

## b. Armored Reconnaissance

The mission of the reconnaissance battalions of armored and motorized divisions, which have comparatively high fire power, is to make contact with the enemy and obtain information on his strength, assembly areas, approach routes, and movements. Contact is usually made frontally, and is shifted around the flanks and rear as enemy resistance stiffens and information is gained. Heavy engagements are avoided, but armored-car patrols are prepared to fight for necessary information. (See fig. 6.)



Figure 6.—Reconnaissance patrol of an SS division. (The patrol consists of motorcyclists and eight-wheeled armored cars. The motorcyclists are armed with rifles, submachine guns, and light machine guns.)

The Germans are likely to employ patrols of eight-wheeled armored cars mounting 75-mm tank guns (a typical patrol generally consists of two such cars), in order to obtain mobility and fire power. Light patrols, equipped with three four-wheeled armored cars or with armored half-tracks, are employed on short-range tasks, liaison missions, and observation; they seldom attempt to fight. Patrols may be reinforced with engineers and motorcyclists to deal

with road blocks and demolitions. Rifle companies belonging to the reconnaissance battalion may be attached to break minor enemy resistance. The fire of their infantry guns may be supplemented by attached field artillery. Tanks are not likely to be furnished as support, because they are too noisy and slow.

Armored reconnaissance patrols carry out missions up to 60 miles deep. On the march, they proceed 40 to 60 miles in advance of the main body, operating on the prongs of a Y on a front of some 20 miles.

Each patrol (in the case of a three-car patrol) marches with a radio car in the rear. Commanding features are approached slowly, and, following careful scrutiny, are rapidly passed. Parallel roads are covered successively. In scouting a wood, the leading car will drive towards the edge, halt briefly to observe, and then drive off rapidly. By this ruse the Germans attempt to draw fire which will disclose the enemy positions. At road blocks, the leading car will open fire. If fire is not returned, men will dismount and go forward to attach long tow ropes to the road block. When necessary, men will dismount and proceed with submachine guns to reconnoiter on foot. Dismounted men are covered by the car's guns. If obstacles prove formidable, or are defended by antitank guns, patrols will report by radio. Pending orders, they will seek a detour. The commander may order the patrol either to by-pass the obstacle or to await reinforcement.

## 5. PATROLS

When German forces were in close contact with Allied forces during the Tunisian Campaign, their patrols did not, as a rule, operate offensively by night, nor did they reconnoiter as deeply as Allied patrols. Many of the German patrols consisted of 30 to 40 men; they moved in close formation at night, making themselves vulnerable to ambush. Rather than make long, deep patrols, the Germans preferred to establish an advanced base from which further patrols were sent out. On the other hand, they made a practice of taking up positions early at night in no-man's land in efforts to ambush Allied patrols.

Of the offensive patrols that were undertaken, virtually all were

made by the Hermann Göring Jäger Regiment. Sometimes three men went forward to reconnoiter while the main body of the patrol waited under cover. The technique was first to make a penetration into a position and then to employ grenades and light machine guns. In the resulting confusion the Germans would attempt to withdraw with prisoners.

Daylight offensive patrols were exceptional, but the striking feature of one such raid was its evidently careful planning. The raid was made by a platoon of the Hermann Göring Jäger Regiment, divided into a fire party, with light machine guns and grenades; an assault party, with grenades and fixed bayonets; and a demolition party. The timing was perfect, no signals were used, and the raid appeared to have been rehearsed. The three parties attacked successively from three directions and the demolition group succeeded in damaging a field gun.

## **6. MEETING ENGAGEMENT**

A German commander will normally avoid a meeting engagement unless he feels that his troops and leadership are superior to the enemy's (this does not necessarily mean numerical superiority), or unless the loss of time in mounting a deliberate attack would result in a sacrifice of terrain which he cannot afford to lose. The Germans teach that it is essential to make sound tactical decisions in the initial stages of a meeting engagement and that mistakes cannot be rectified, but they believe that the worst mistake is hesitation.

When the Germans do commit themselves to a meeting engagement, they will deploy the main body immediately. They proceed on the principle that time lost in such circumstances cannot be regained, and, therefore, they deem it wrong to lose time in the hope of clarifying the situation. Their normal tactics then would be to coordinate a frontal assault of the advance guard with one or more enveloping attacks by the main body. Great emphasis is laid on obtaining superiority in the fire fight by a liberal allotment of supporting weapons.

## 7. DEPLOYMENT

The Germans carry out deployment in two stages. They call the first stage *Entfaltung*, or "shaking out," which is equivalent to the development of a march column according to U. S. procedure. In the first stage (fig. 7<sup>Ⓞ</sup>, p. 14), an infantry regiment normally deploys down to battalions, although the procedure may go down to companies if a high state of preparedness is necessary. The second stage (fig. 7<sup>Ⓞ</sup>, p. 14), called *Entwicklung*, is deployment in detail, which is the final action of the company extending itself down to platoons and squads. A factor considered by the Germans in determining when to deploy is the additional physical strain placed on men when they march cross-country.

Features of the first stage of deployment are as follows:

(a) Companies retain their combat vehicles until their weapons and equipment arrive at the off-carrier position, which is located as far forward as the situation permits.

(b) The Germans often place only one company forward, the main strength of the battalion being kept under control of the battalion commander as long as possible so that he may employ it in the most advantageous direction for attack.

(c) If the condition of the terrain and enemy fire cause a change of intervals between units, the normal intervals are resumed as soon as possible.

(d) Support weapons are used to cover the "shaking out" phase of deployment and the subsequent advance, the weapons being kept within the march column between the companies or behind the battalion.

(e) After the first stage of deployment has been carried out, the leading elements of the battalion may be ordered to seize important tactical features.

(f) When deploying by night or in woods, a careful reconnaissance is made, routes are marked, and strong protection is placed forward. Intervals between units are shorter.

(g) After the first stage of deployment has been completed, the battalion commander marches with the leading elements and will normally send reconnaissance patrols ahead or reconnoiter the enemy position himself. The commanders of support weapons accompany him, reconnoitering for firing positions.

Features of the second stage of deployment are as follows:

(a) The companies deploy in depth as soon as they come within range of artillery fire. An advance in columns of files is considered desirable because it affords a small target and the company is easier to control, but before adopting this formation the danger of enfilading fire is weighed.

(b) If enemy fire and difficult terrain necessitate further deployment, the com-

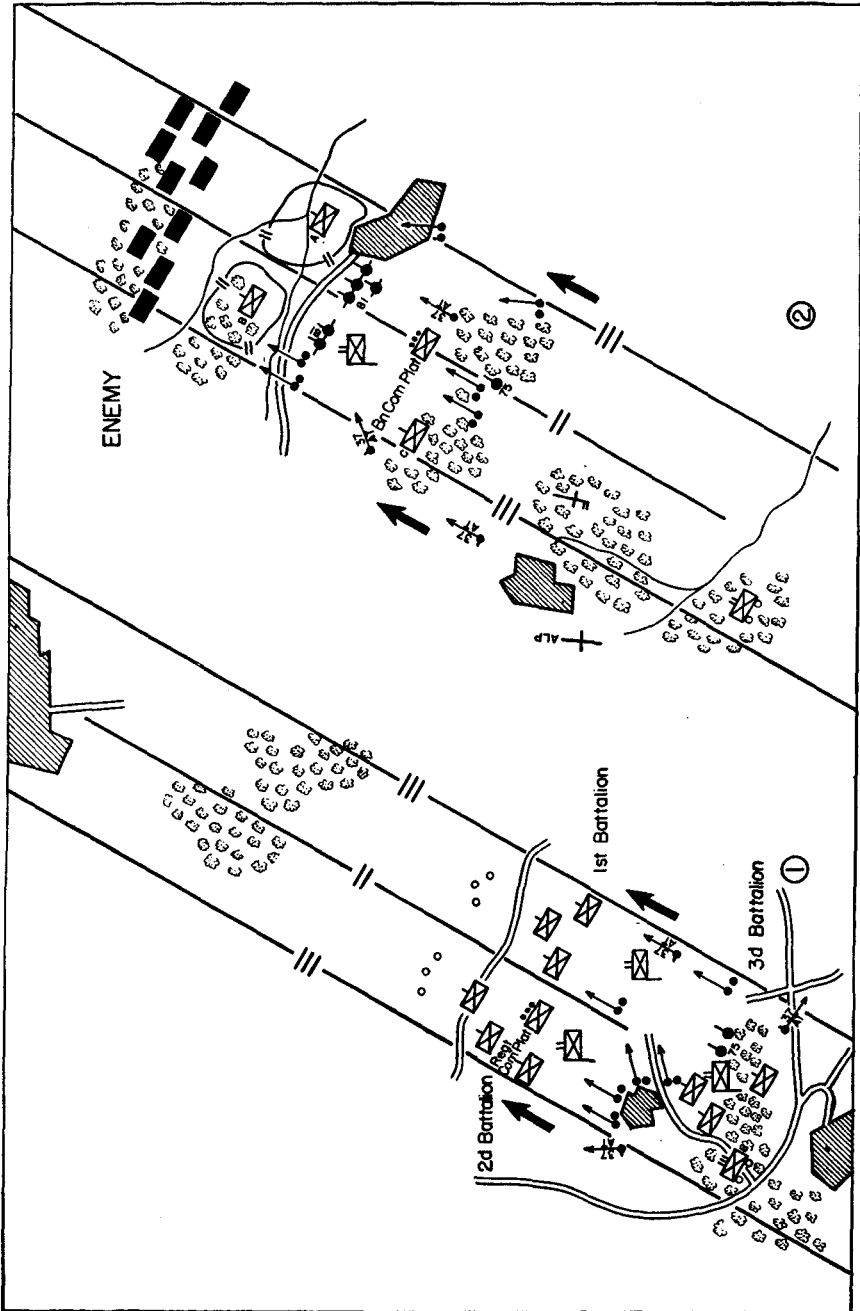

Figure 7.—Deployment of a German infantry regiment:  
① first stage (deployment by battalions);  
② second stage (deployment in detail).



panies disperse in depth by sections. Reserves and support weapons also adopt open formations, but they remain far enough behind to avoid coming under the fire directed at the leading elements.

(c) When the rifle companies are deployed, they exploit all possible cover as they advance, employing single-file or column-of-file formations with irregular intervals. The leading elements are not extended until they are to engage in a fire fight. The elements that follow continue advancing in file.

## Section II. DEFENSIVE PRINCIPLES

---

### 8. GENERAL

In the defensive, the Germans rely on heavy concentrations of fire and on powerful, coordinated counterattacks by mobile reserves of all arms. They apply to the defense as well as to the attack the principle of selecting a point of main effort (*Schwerpunkt*). This principle (which is discussed in par. 1, p. 2) is necessarily applied in reverse order in the defensive, the main defensive effort being made opposite the point where the enemy is making his main attack. When the Germans have determined the direction and scope of the main attack, they invariably counterattack with the bulk of their strength at a flank or from the rear. Shock action and surprise characterize this counteraction.

The counterattack force is specially organized and is located in an assembly area behind a vital or vulnerable sector of the main line of resistance. The plan for the counterattack is prepared in detail on the basis of probable enemy action and is carefully rehearsed in advance. If tanks are not available for participation in the counterattack, the Germans will endeavor to achieve superiority by increasing the strength of the other available forces.

In the initial stages of the defense, the Germans endeavor to destroy an attack with a concentration of fire from all weapons before the enemy reaches the main line of resistance. The fire of infantry support weapons and of artillery is superimposed on the areas covered by the lighter infantry weapons, especially along terrain favoring the enemy's approach. Quick and accurate fire, especially from machine guns, heavy mortars, and light infantry guns, is brought to bear at threatened points. Weapons are moved to previously prepared emplacements and alternate positions, as the situation warrants. Wherever possible, the Germans site their support weapons, particularly mortars, on reverse slopes. The capabilities of the heavy mortar are exploited, the present trend in the German Army being to concentrate mortar fire (see par. 13b, p. 27).

Penetrations are dealt with immediately by means of local counterattacks by small groups of infantry. Even these small counter-

attacks are directed, if possible, at the flanks of the penetrations.

Small, close-range tank-hunting detachments are formed for active defense against armored vehicles, and they may operate forward of the main line of resistance. But German manuals prescribe that all arms must be prepared to engage tanks at close range, and therefore must learn to use approved methods and equipment. German infantry is trained to remain under cover (*Panzerdeckung*) until hostile tanks have passed, and then to emerge and attack the enemy infantry that follows the tanks. If enemy tanks penetrate, the Germans counterattack with special, mobile groups equipped with a large number of antitank weapons. These groups are held ready in the depth of the position, especially in the rear of vulnerable sectors, and attack the flanks and rear of the enemy tank force.

If a break-through occurs, the reaction is an immediate and heavy counterattack, which is supported by heavy fire from all infantry support weapons and artillery, including assault guns and other artillery on self-propelled mounts. The Germans have stated that assault artillery, when employed in the defense, must be held as a counterattack reserve under the control of a sector commander.

## 9. TANKS IN DEFENSE

In employing tanks in the defensive, the Germans apply the same general principle of concentrating tanks as laid down for the attack (see par. 2, p. 5), except that the tanks must be prepared for tank-versus-tank action. When a German armored force is compelled to assume a defensive role by an enemy armored attack, it will usually, if time permits, deploy its antitank guns and part of its tank force as a screen. Behind this screen the artillery is deployed, the main tank force and its motorized infantry being held as a mobile reserve.

Whenever a situation makes it necessary, however, the Germans depart from their principle of concentrating tanks, giving them static missions in the coordinated fire plan of a defensive position. For instance, tanks may be dug in or driven into specially built tank emplacements, so that they are virtually converted into armored pillboxes.

On one occasion on the Eastern Front it was reported that a company of *Tiger* tanks took up defensive positions (presumably

hull-down) forward of the infantry positions. They engaged advancing tanks and infantry, firing their machine guns as well as their heavier weapons from the halt.

During the Tunisian Campaign, *Tiger* tanks were used effectively in the defensive, in covered and defiladed positions. They were often employed hull-down in very difficult terrain. Light and medium tanks rarely took up good defensive positions of their own, but were employed to cover the flanks of the *Tiger* tanks. Medium tanks were often used in small groups to counterattack from concealed flank positions.

## 10. DEFENSE OF TOWNS

The Germans regard towns and villages as excellent strongpoints, particularly if the buildings are of masonry. Towns are also regarded as excellent antitank positions because of the considerable infantry-artillery effort necessary to dislodge or neutralize them.

In defending a town or village, the Germans locate their main line of resistance well within the built-up portion; the edges of the town are believed to be too vulnerable, and to provide easy targets for artillery fire. The main line of resistance is laid out irregularly in order to develop flanking fire, and every effort is made to conceal its location until the last possible moment. Furthermore, minor strongpoints are maintained forward of the line in order to break up attacks and to provide additional flanking fire. Cul-de-sacs are organized and attempts are made to trap attacking forces in them, and to destroy them by counterattacks launched by mobile reserves. The reserves are held in readiness within the town itself; other reserves are held outside the town to prevent attacking forces from carrying out flanking action.

In organizing the defended positions, both occupied and unoccupied buildings are booby-trapped. The entrances to buildings are blocked up. All windows are opened so as not to disclose those from which fire is maintained. Rooms are darkened and passages are cut in the walls between buildings. Communication is maintained through cellars and over roofs. To avoid detection, the Germans fire from the middle of the rooms, and frequently change their positions. Machine guns are sited low, usually in basements, to provide

better grazing fire. Chimneys and cornices are used as cover for men on roofs; tiles may be removed to provide loopholes. Searchlights are mounted to illuminate fields of fire; in their absence, vehicle headlights may be used as substitutes. When houses collapse, the defense is carried on from cellars. Rubble heaps of destroyed areas are organized into strongpoints.

Tanks are considered to be ineffective within a defended town, although the Germans have used them in static, dug-in positions at crossroads and squares. As a result of their experiences on the Eastern Front, the Germans teach that single tanks are too vulnerable to Molotov cocktails, T-mines (Tellermines), magnetic mines, and explosive charges. When the Germans employ these antitank defenses, they dig foxholes outside the perimeter of the town. Efforts are made to destroy enemy tanks immobilized by antitank action, either within or outside the town, in order to prevent their recovery or their use as artillery observation posts and machine-gun nests. Antipersonnel mines are interspersed in antitank mine fields because it is the attacking infantry that is chiefly feared.

If attacking forces break through and disorganize the German position, assault guns may be employed to provide direct support fire. To secure the added protection afforded by masonry walls, the Germans may locate assault guns or tanks within buildings and use them against armored vehicles and infantry. Counterattacks supported by assault guns or tanks will not necessarily be withheld until the situation has become desperate; surprise counterattacks may be launched at any time.

## 11. ORGANIZATION OF A DEFENSIVE POSITION

### a. Covering Position

In German practice, the main purpose of the covering position (*vorgeschobene Stellung*) is to compel the enemy to deploy early, and to prevent him from occupying terrain features which would assist him in an attack on the main defensive position. It is usually 5,000 to 7,000 yards forward of the main line of resistance. The covering position is also designed by the Germans to allow forward

artillery observation posts to operate as long as possible, and to prevent enemy reconnaissance of the battle position.

The forces occupying the covering position usually are reconnaissance detachments, including machine-gun units. Their vehicles include armored cars and assault guns. These forces receive support from artillery and antitank guns. Their mission is to occupy important features, such as railways, crossroads, river crossings, and elevations; to carry out demolitions and patrolling; and to bring in early information concerning the direction of an enemy attack.

### **b. Outpost Position**

Outposts (*Vorposten*) are normally established 2,000 to 5,000 yards forward of the main defensive position, depending on the nature of the terrain, and they are occupied by troops ranging in strength from platoons to companies. The purpose of the outpost position, according to German doctrine, is to gain time for the troops occupying the main defensive position, thus enabling them to determine the direction of the enemy's main attack and to prepare to meet it. Like the covering position, the line of outposts also has the mission of compelling the enemy to deploy and to prevent him from making ground reconnaissance of the main defensive position and of the terrain immediately in front of it.

The outpost position is supported by the fire of close-support weapons (mortars, infantry guns, and machine guns). Antitank guns may be emplaced in the position for the purpose of repelling armored reconnaissance units. The troops occupying the outposts will fight stubbornly to protect forward observation outposts until they are ordered to withdraw. The outposts may be withdrawn at a specified time, or when the enemy appears to be developing a major attack. The withdrawal is carefully planned in order to avoid masking the fire of the main position. Once the outposts are abandoned, they are likely to be covered by the carefully registered fire of infantry support weapons in order to prevent their occupation by the enemy.

### c. Main Defensive Position

The Germans organize their main defensive position (*Hauptkampffeld-Stützpunkt*) in depth, with the majority of the infantry weapons placed in positions from which fire can be laid down forward of the main position (fig. 8, p. 22).

Depth, cover, and deep digging for protection against artillery fire are especially emphasized in laying out infantry positions. The defense of the position is based on mutually supporting centers of resistance, or hedgehogs (*Igel*), each of which is capable of all-around defense. In terms of space, a German battalion is assigned a sector of 800 to 2,000 yards of the position. The main pivot of the defense is the forward edge of the position (main line of resistance), which includes localities that must be held at all cost.

The Germans endeavor to provide all parts of their position with strong support from infantry support weapons as well as by artillery. An elaborate plan of coordinated fires is prepared in advance, and these fires are directed from observation posts which are sited well forward. Alternate emplacements are dug so that support weapons may be shifted and fired rapidly. Light and heavy infantry guns complement the artillery where it is necessary to intensify the artillery fire and where artillery fire cannot be laid.

In constructing the position the Germans stress the construction of obstacles and the preparation of antitank defenses; if possible, they select tank-proof terrain. They insist on very careful camouflage, but adhere to the principle of "effect before cover." Considerable use is made of dummy and alternate positions in order to deceive the enemy into dissipating his fire. Emplacements are dug and gradually developed into a system.

Antitank guns are disposed in depth, some well forward, and they are often dug in and carefully concealed to prevent the enemy from discovering, before an attack, the actual strength and location of the antitank defenses. In emplacing antitank guns the Germans prefer positions in enfilade or on reverse slopes. It is likely that three antitank guns (most likely of 75-mm caliber) will be used in each company position, while three more usually are kept with each battalion's reserve of mobile guns.

During the Tunisian Campaign the Germans used 88-mm dual-

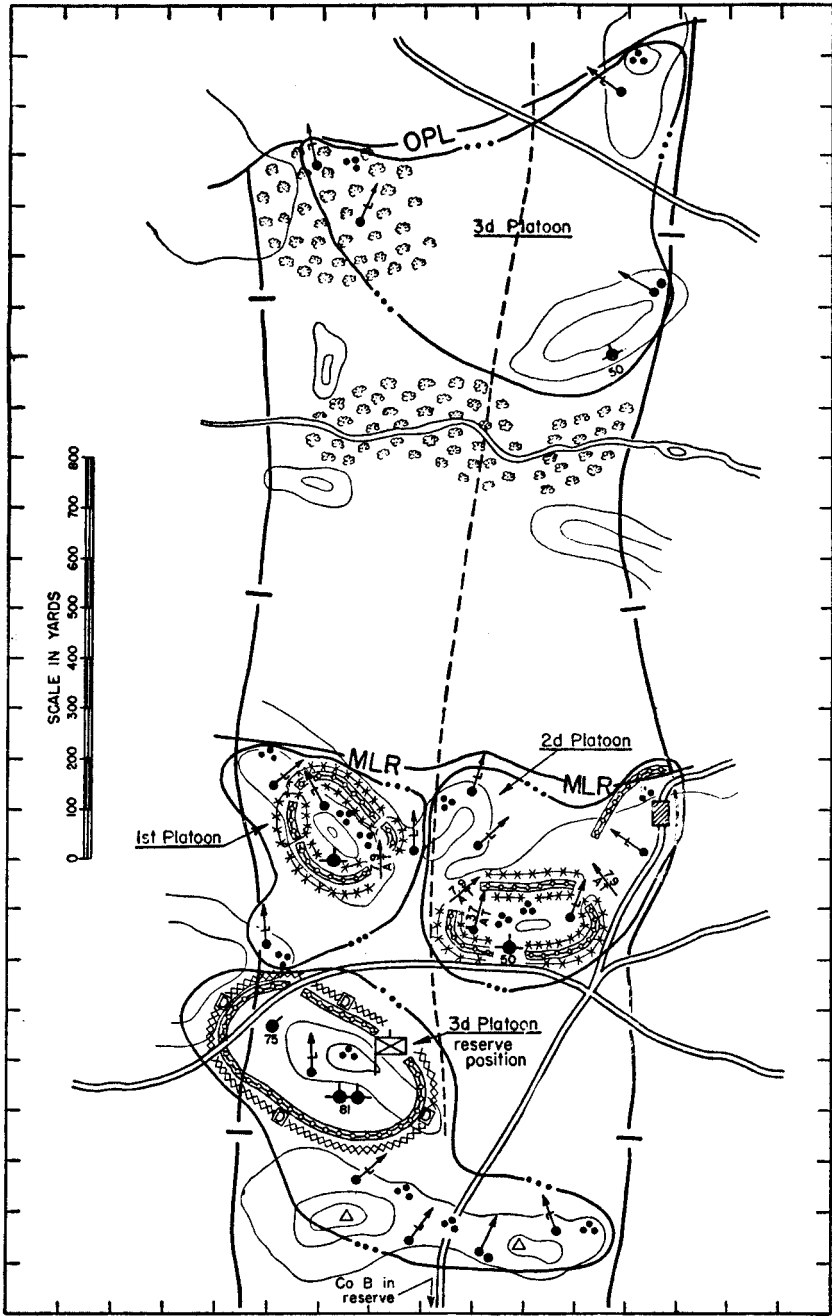

Figure 8.—German company in a defensive position.



purpose guns in batteries of four guns, with two or three batteries supporting each other. The guns were carefully camouflaged. In the same campaign they used the 75-mm gun with almost equal effectiveness. The Germans also effectively employed the 50-mm antitank gun by using it at a range of 300 to 400 yards, the German gunners proving themselves well-disciplined in holding their fire until targets came within this range.

Where indirect fire was impracticable, the Germans sited their 88's and 75's on forward slopes in order to take maximum advantage of their long ranges and telescopic sights. In one instance an 88 was used on a roving antitank mission, its ammunition dumps having been prepared in advance at suitable points in the terrain. During the last stage of the Tunisian Campaign, however, many of the 75's were sited on reverse slopes with fields of fire of only 200 to 300 yards.

A report dealing with a typical layout for an antitank company stated that the platoons were in line, with guns echeloned, each platoon having two guns forward 200 yards apart, with the third gun in the rear, between the two forward guns. The nearest gun of the neighboring platoon was 300 yards away. One light machine gun was emplaced on either side of the position, in line with the foremost guns and about 30 yards from the nearest gun.

In the Tunisian hills the Germans also usually sited their 50-mm guns on reverse slopes, up to 400 yards behind the crest, in order to engage tanks coming over the top. Self-propelled guns were used from hull-down positions, and sometimes tanks concealed themselves in gullies running at right angles to the direction of the Allied advance in order to engage tanks.

On the Russian front the Germans engaged tanks with single antitank guns at ranges of 600 to 1,000 yards in front of the main line of resistance, but their main antitank defenses opened fire when the range was reduced to about 150 to 300 yards. These main defenses were usually sited for enfilade fire from carefully concealed dug-in positions.

Extensive use is made by the Germans of mine fields within and around the position. All mine fields are covered by fire; snipers are included for daylight protection, while artillery and machine guns on fixed lines of fire cover the mine fields at night.

Deception and surprise are basic factors in German mine-field practice. Although regular patterns are the most common, regularity and symmetry should never be assumed in German mine fields. Even fields laid out in a strictly exact pattern will have additional mines scattered irregularly around their edges. Furthermore, long, narrow belts of mines may be extended from the mine fields in the direction of the enemy in order to hamper lateral traffic along the forward edge of the fields.

## **Section III. EMPLOYMENT OF SUPPORT WEAPONS**

---

### **12. MACHINE GUNS**

In siting machine guns the Germans stress the possibilities for enfilade. During the present Italian Campaign a German division commander criticized subordinate unit commanders because they had violated this principle. He found that light and heavy machine guns too often were sited frontally. This was done to avoid having 50 to 100 yards of dead space in front of their positions. Stating that this approach to the problem was wrong, the division commander ordered that the majority of the machine guns must be sited to fire from flanks, and from positions screened from frontal observation and fire (from reverse slopes, including the forward slope in a depression, from behind cover such as hedges, etc). The division commander went on to explain that if the enemy did succeed in reaching the dead space, the machine guns could be shifted quickly to previously prepared, close-range positions from which the area could be covered.

The German division commander further objected to attempts to obtain, also by frontal siting, a field of fire of 500 yards and more in depth with light machine guns. He stated that light machine guns are employed correctly when they are sited to fire at 250 yards, because at this range light machine guns are "splendidly accurate." The German commander concluded as follows: "When the enemy is within this distance (250 yards) of our machine-gun positions, he is unable, because of the area of the beaten zone of the shells, to use his artillery against the machine-gun positions. His infantry is then completely exposed to the devastating fire of our light machine guns, snipers, automatic rifles, etc."

During the Tunisian Campaign the evidence also indicated that the Germans insisted on siting their machine guns for enfilading fire. They placed their machine guns in defiladed, well-concealed flank positions, satisfying themselves with a small arc of fire in order to do so. Furthermore, they employed alternate positions to a considerable extent. The machine guns were also sited on reverse

slopes in order to fire on attacking infantry situated on or approaching another objective, and also to engage infantry coming over the sky line. The reverse-slope positions also prevented attacking infantry from discovering the machine-gun positions quickly and made it difficult for artillery to fire effectively on them.

### **13. INFANTRY HOWITZERS AND MORTARS**

#### **a. Infantry Howitzers**

The German 75-mm and 150-mm infantry howitzers are regimental weapons, and their function is to accompany the infantry and fire on those targets which are too close to German troops to be engaged by field artillery. They also fire on targets of opportunity. In the attack, they are placed at the disposal of the assault battalion commander, and move with his battalion. They engage personnel, emplacements, and, using hollow-charge projectiles, armored vehicles. Both light and heavy infantry howitzers normally deliver indirect fire from covered positions, but in Tunisia they usually were used for direct fire, and their positions were changed frequently. In the hilly terrain of Tunisia, Sicily, and Italy, however, the Germans preferred the mortar as an accompanying weapon for infantry.

In defense, infantry howitzers are also allocated to front-line battalions. Usually they are placed back of the main line of resistance. Their high-trajectory fire is utilized to deny likely covered approaches to the German main position.

The 75-mm howitzer can easily be manhandled by an individual soldier over fairly level ground. It has a very low silhouette. The 150-mm howitzer is much larger and heavier, and is intended primarily to engage strong centers of resistance. Because a small supply of ammunition is allowed for offensive purposes, it usually reserves its fire until moments of maximum effort. Infantry howitzers (especially the 75-mm) are well-adapted for inclusion in rear guards or advanced guards for the destruction of road blocks and the dispersal of covering forces and unarmored or light armored vehicles.

## b. Mortars

The 50-mm mortar is usually sited by the Germans to fire immediately forward of the main line of resistance against an enemy who is using covered approaches and cannot be reached by machine-gun fire. When held in a reserve platoon, this weapon is sited to participate in defensive fire as well as to support counterattacks.

In recent operations the Germans have tended to depart from their previous practice of employing 81-mm mortars by individual sections (two mortars in a section), or assigning them singly to companies and smaller units. They prefer to concentrate these weapons, placing emphasis on the devastating effect of surprise concentrations.

The fire unit is the section. When a number of sections are concentrated, the senior officer will be forward in a main observation post. This officer may direct the fire by giving a target designation to a section within shouting distance. This section will indicate the target to other sections by ranging with one mortar. The use of this method, however, does not mean that normal means of indicating targets and directing fire are not used.

Available information on the German 120-mm mortar indicates not only that it has been introduced in mountain rifle regiments and panzer-grenadier regiments but that 120-mm mortar battalions, motorized and under control of GHQ, have been created as a result of new concepts on the employment of this weapon. The Germans have based their technical and tactical employment of this weapon on a combination of artillery methods and techniques for the employment of the infantry gun and the 81-mm mortar. The following is an excerpt from a German document concerning the employment of the 120-mm mortar: "As the mortars use only high-angle fire, it is necessary to find positions from which all crests can be cleared. The fire unit is the platoon, the tactical unit the company. To obtain an especially effective concentration of fire, the battalion can be employed en masse under the fire control of the battalion commander. Splitting up the battalion into units smaller than a company dissipates and reduces the effectiveness of the fire."

## 14. ROCKET PROJECTORS

For laying heavy concentrations of smoke and for massed fire on area targets, the Germans have introduced various types of rocket projectors. Ten types have thus far been identified, and at least one of them is mounted on an armored tracked vehicle. The more common types, mounted on two-wheeled tired carriages, are the 150-mm six-barreled projector (*15 cm Nebelwerfer 41*), the 210-mm five-barreled projector (*21 cm Nebelwerfer 42*), and the 280-mm and 320-mm projector (*28/32 cm Nebelwerfer 41*) (see par. 23, p. 50). Because the projectors are comparatively light (the 150-mm weighs 1,200 pounds, and the 210-mm, developed later, weighs 100 pounds less—1,100 pounds), they are far more mobile than field artillery weapons firing projectiles of similar weights. However, the rocket projectors do not have the accuracy of artillery. Consequently, when covering area targets with high-explosive rocket fire, the Germans employ the projectors at medium ranges; their dispersion is too great for fire on targets close to friendly troops. Another tactical use made of the projectors is to build up smoke *Schwerpunkte* (points of main effort) to blind critical areas, enemy gun positions, and observation posts.

The 150-mm projector, which can be manhandled easily by two men, has been used extensively, often as a substitute for artillery in the kind of terrain found in Tunisia, Sicily, and Italy. Available information indicates that the Germans have organized smoke regiments equipped with the 150-mm mortar, and that the fire unit is a battery of six projectors. The batteries go into position with projectors loaded; they are towed as far forward as possible and manhandled into position, generally on reverse slopes.

# Section IV. WEAPONS, OBSTACLES, AND VEHICLES

## 15. RIFLES AND CARBINES

### a. General

The standard German rifle (or long carbine) is the Mauser *Karabiner 98K* (figs. 9 and 10). There are two older types (*Karabiner 98b* and *Gewehr 98*) which are similar but have longer barrels and

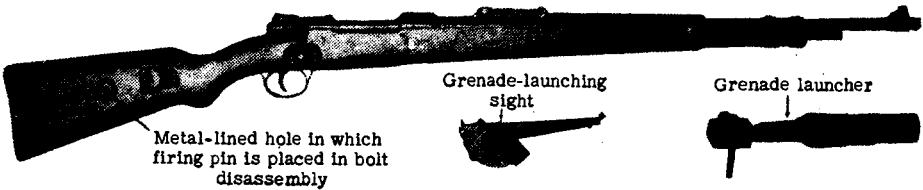

Figure 9.—Side view of the standard German rifle (*Karabiner 98K*), showing grenade-launching attachments.

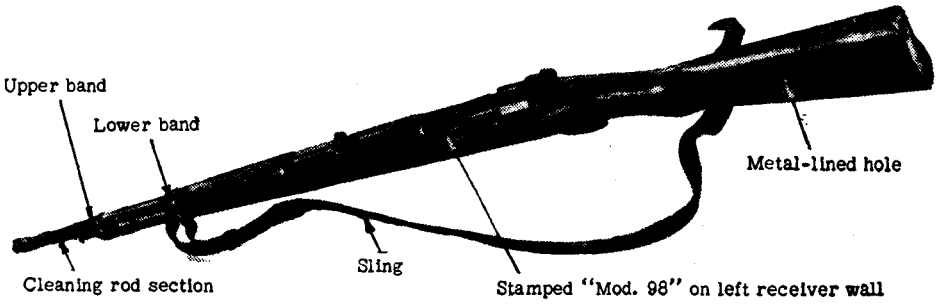

Figure 10.—Top view of the standard German rifle (*Karabiner 98K*).

minor variations in accessories. A semiautomatic rifle (*G. 41* and *G. 43*), comparable to the U.S. M1 (Garand), has recently been developed and is now in use. (For the principal characteristics of the *Karabiner 98K*, see fig. 11, p. 30.)

Caliber.....	7.92 mm (.312 inch)
Principle of operation.....	Bolt-operated
Length of barrel.....	23.4 inches
Over-all length.....	43.5 inches
Sights:	
Front.....	Inverted V blade (which is sometimes equipped with a hood to provide shade)
Rear.....	Leaf with open V notch sliding on ramp, graduated from 100 to 2,000 meters; no windage adjustment
Muzzle velocity.....	2,800 feet per second (approximate)
Range:	
Maximum.....	3,000 yards (approximate)
Effective.....	800 yards (approximate)
Ammunition.....	See par. 15b
Capacity of magazine.....	5 rounds
Weight.....	9 pounds (approximate)

Figure 11.—Characteristics of the standard German rifle (Karabiner 98K).

## b. Ammunition

The four main types of service ammunition used in 7.92-mm (.312-inch) rifles, carbines, and machine guns are as follows: ball (*schweres Spitzgeschoss*, or *s.S.*), armor-piercing (*Spitzgeschoss mit Stahlkern*, or *S.m.K.*), armor-piercing tracer (*Spitzgeschoss mit Stahlkern und Leuchtspur*, or *S.m.K. L'Spur*), and antitank (*Spitzgeschoss mit Stahlkern gehärtet*, or *S.m.K.H.*). (For identification marks, see fig. 12.)



Two types of cartridge case, indicated by S\* for copper or ST for steel

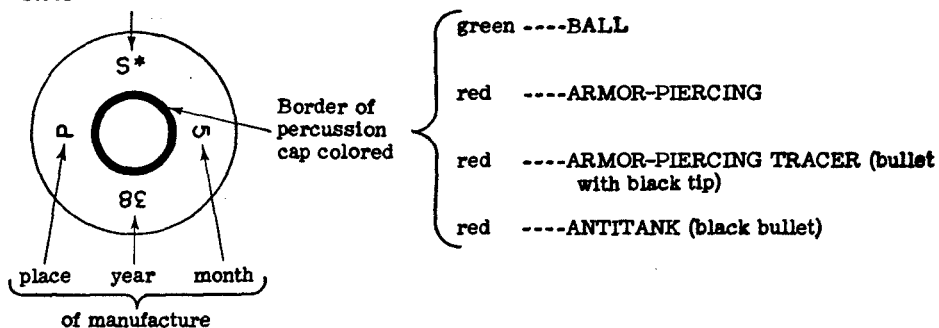

Figure 12.—Identification marks of German 7.92-mm small-arms ammunition.

### c. Grenade Launchers

Rifle grenades may be discharged from the rifle by the use of grenade launchers, of which there are two types: spigot and cup. (For details of rifle grenades, some of which can be used instead as hand grenades, see fig. 19, p. 36.)

## 16. PISTOLS

The pistol commonly used by the German Army is the Luger (*Pistole 08*). The Walther pistol (*Pistole 38*) and a Czech pistol designated as *Pistole 39* are also used. (See figs. 13 and 14, p. 32.)

These 9-mm (.354-inch) pistols have a higher muzzle velocity and greater penetration than the U.S. 45-caliber pistol, but because of their smaller caliber they have less shock power. (For the principal characteristics of Luger and Walther pistols, see fig. 15, p. 33.)

## 17. SUBMACHINE GUNS

The 9-mm submachine gun (*Maschinenpistole*) is widely used in the German Army, especially by armored-vehicle and parachute troops. In the infantry it is carried by squad and platoon leaders. The most common models are the models of 1938 and 1940 (*M.P. 38* and *M.P. 40*) (see figs. 16, p. 34, and 17, p. 35), which are, for all practical purposes, substantially similar.

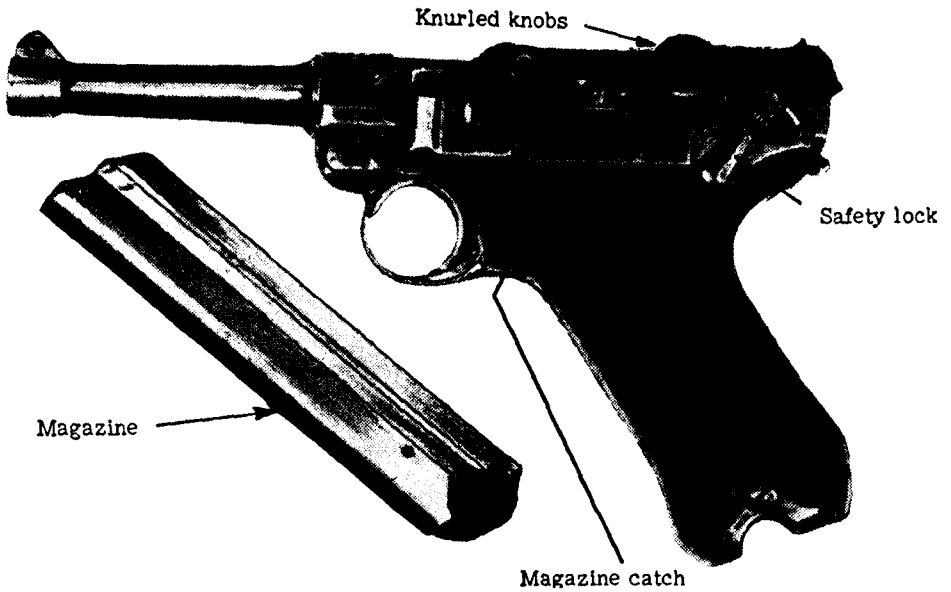

Figure 13.—Luger pistol (*Pistole 08*) and magazine.

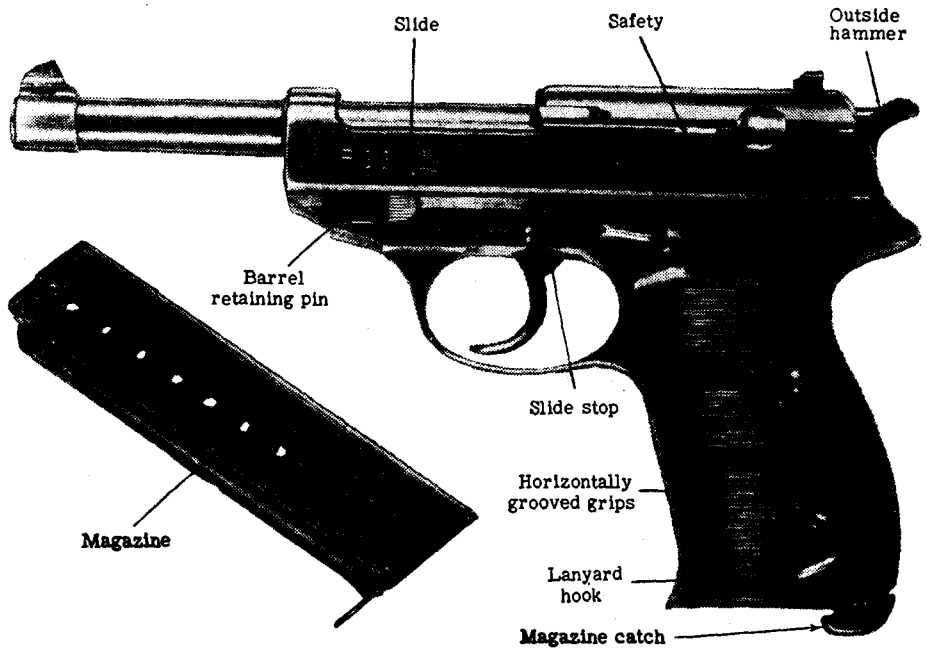

Figure 14.—Walther pistol (*Pistole 38*) and magazine.

Type.....	Luger ( <i>Pistole 08</i> )	Walther ( <i>Pistole 38</i> )
Principle of operation....	Recoil-operated	Recoil-operated; double-action trigger mechanism
Length of barrel.....	4.25 inches	4.75 inches
Sights:		
Front.....	Inverted V blade	Inverted V blade
Rear.....	Open V notch, non-adjustable	Open V notch, non-adjustable
Muzzle velocity.....	1,040 feet per second	1,040 feet per second
Range:		
Effective.....	25 yards	25 yards
Maximum.....	1,150 yards	1,150 yards
Ammunition.....	9-mm Parabellum (German, British, Italian, or U. S. manufacture)	9-mm Parabellum (German, British, Italian, or U. S. manufacture)
Capacity of magazine....	8 rounds	8 rounds

Figure 15.—Characteristics of Luger and Walther pistol

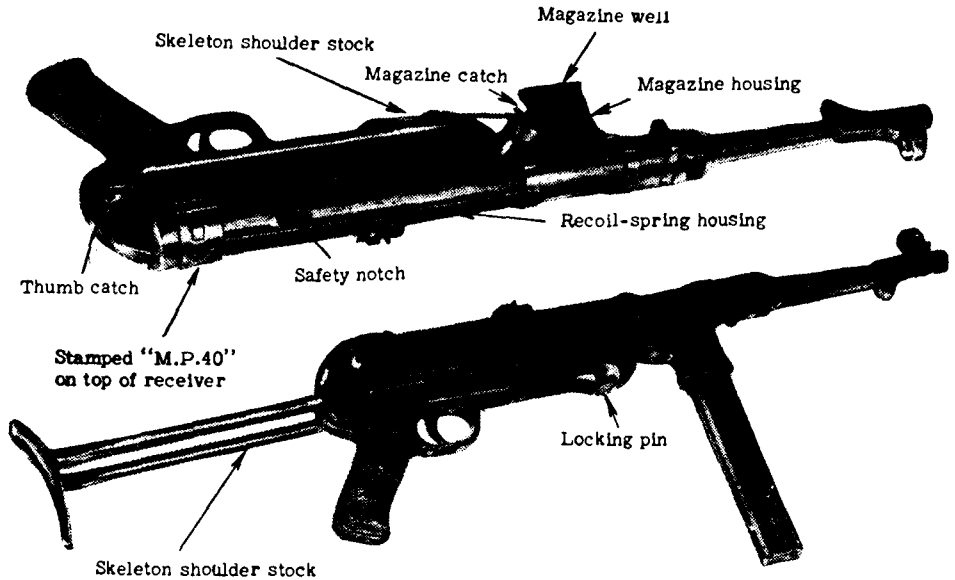

Figure 16.—Two views of the M.P. 40, showing skeleton shoulder stock folded (above), and open (below).

## 18. GRENADES

### a. General

The hand grenades used by the German Army are all of the "offensive" type: that is, they have a thin metal casing with a high proportion of explosive filler. Being of this type, they depend on blast effect instead of on the fragmentation of the case as in the U.S. "defensive-type" Mills grenades. German hand grenades can be used safely by troops advancing erect in the open, because they can be thrown beyond their effective radius. The model 24 (fig. 18) and the model PH 39 stick-type, or "potato masher"-type, hand grenades are used more often than the "egg"-type, and may be considered the standard hand grenades of the German Army. Several types of rifle and pistol grenades, some of which can also be used alternatively as hand grenades, are also in use (see fig. 19, p. 36).

Caliber.....	9-mm (.354 inch)
Principle of operation.....	Straight blowback, full-automatic fire only
Length over-all, with shoulder stock open.....	33 1/2 inches
Sights:	
Front.....	Inverted V blade, with cover
Rear:	
Fixed.....	Open V notch, sighted to 100 meters (109 yards)
Folding.....	Open V notch, sighted to 200 meters (219 yards)
Range:	
Effective.....	200 yards
Maximum.....	1,850 yards
Rate of fire:	
Theoretical.....	520 to 540 rounds per minute
Practical.....	80 to 90 rounds per minute (in short bursts)
Ammunition.....	9-mm Parabellum pistol ammunition (9-mm British Sten machine carbine ammunition also usable)
Capacity of magazine.....	32 rounds in removable box magazine
Weight (with loaded magazine).....	10 pounds 7 ounces

Figure 17.—Characteristics of the M.P. 38 and M.P. 40.



Figure 18.—Stick-type hand grenade, model 24.

Type.....	Stick-type hand grenade, model 24	Stick-type hand grenade, model PH 39	Egg-type hand grenade, model 39	Hollow-charge rifle grenade, antitank (spigot-launched)	Hollow-charge rifle grenade, antitank (cup-launched)	Rifle grenade, antipersonnel	Pistol grenade, antipersonnel
German designation	<i>Stielhandgranate 24</i>	<i>Stielhandgranate PH 39</i>	<i>Eihandgranate 39</i>	<i>Gewehr-Panzergranate</i>	<i>Gewehr-Panzergranate</i>	<i>Gewehr-Sprenggranate</i>	
Over-all length.....	1 foot 2 inches	1 foot 4 inches	About 3 inches	About 9 inches		6 inches	
Weight (complete).....	1 pound 5 ounces	1 pound 6 ounces	8 ounces		Two sizes: 8½ and 13 ounces <sup>1</sup>	9 ounces	5 ounces
Weight of explosive filler.....	6 ounces	7 ounces	4 ounces		Two sizes: 1.75 and 4.5 ounces <sup>1</sup>	1 ounce	
Delay time (used as hand grenade).....	4 to 5 seconds	4 to 5 seconds	4 to 5 seconds			4 to 5 seconds	
Effective blast radius.....	12 to 14 yards	16 yards					
Range.....	About 30 yards	About 30 yards	About 30 yards	About 100 yards	About 100 yards	About 250 yards from rifle, or about 30 yards as hand grenade	About 150 yards
Remarks.....			May be fired from signal pistol when equipped with adapting stem	Fired from spigot-type launcher	Fired from cup-type launcher	Fired from cup-type launcher, or thrown by hand; fragmentation about 30 yards	Fired from 27-mm Walther rifled signal pistol

<sup>1</sup>For the *grosse Gewehr-Panzergranate*.

Figure 19.—Characteristics of common grenades.

## b. Use

Stick-type grenades are sometimes bound in a group for use as demolition charges or improvised Bangalore torpedoes, or are adapted for use as antipersonnel mines. All types are used in making booby traps, and a common trick is to remove the delay element.<sup>1</sup>

## 19. MACHINE GUNS

The standard machine guns of the German Army are the *M.G. 34* (*Maschinengewehr 34*) (fig. 20) and the newer *M.G. 42*. Both of these are multipurpose, air-cooled weapons with a caliber of 7.92 mm (.312 inch). They are substantially similar in their characteristics (see fig. 21, p. 38), except that the *M.G. 42* (fig. 22, p. 39) has

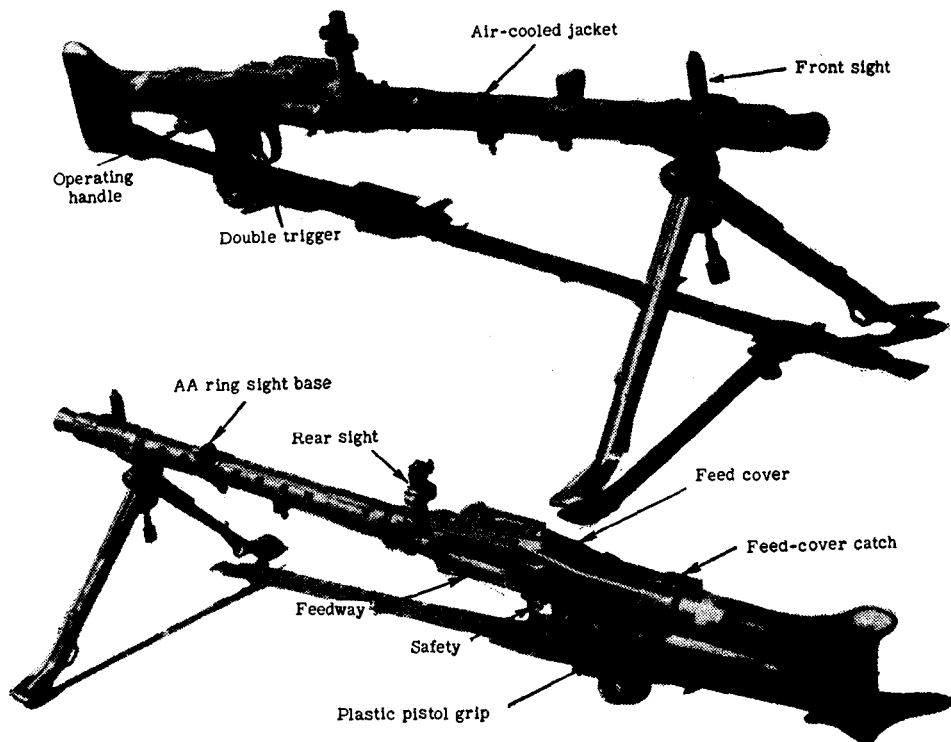

Figure 20.—Two views of the *M.G. 34* on bipod mount.

<sup>1</sup> For operation and for safety precautions in handling grenades, see "German Infantry Weapons," *Special Series*, No. 14 (25 May 1943), pp. 40-52.

Type.....	<i>M. G. 34</i>	<i>M. G. 42</i>
Principle of operation.....	Short recoil assisted by muzzle blast	Short recoil and blowback assisted by muzzle recoil booster
Sights.....	Blade front sight and leaf rear sight with open <b>V</b> notch graduated from 200 to 2,000 meters (219 to 2,187 yards); a folding rear peep sight for use with antiaircraft ring sight; and a telescopic sight graduated up to 3,500 meters (3,827 yards) for use as heavy machine gun	Adjustable inverted <b>V</b> front sight and leaf rear sight with open <b>V</b> notch sliding on ramp and graduated from 200 to 2,000 meters (219 to 2,187 yards); a folding rear peep sight for use with antiaircraft ring sight; and a telescopic sight graduated up to 3,500 meters (3,827 yards) for use as heavy machine gun
Muzzle velocity.....	2,500 to 3,000 feet per second (depending on ammunition)	2,500 to 3,000 feet per second (depending on ammunition)
Range:		
Maximum.....	5,000 yards	
Effective.....	<i>See under Sights, above.</i>	<i>See under Sights, above.</i>
Rate of fire (rounds per minute):		
Maximum.....	900	1,500
Practical:		
As light machine gun (on bipod).....	150	154
As heavy machine gun (on tripod).....	250	
Ammunition.....	All 7.92 ammunition except anti-tank rifle ammunition. (See par. 15b, p. 30, and fig. 12, p. 31.)	All 7.92 ammunition except anti-tank rifle ammunition. (See par. 15b, p. 30, and fig. 12, p. 31.)
Type of feed.....	1. Nondisintegrating metallic-link belts, which hold 50 rounds and may be connected in series 2. 50-round belts in metal drum 3. 75-round double (saddle-type) drums	1. Nondisintegrating metallic-link belts, which hold 50 rounds and may be connected in series 2. 50-round belts in metal drum
Weight:		
As light machine gun (on bipod).....	26½ pounds	25½ pounds
As heavy machine gun (on tripod).....	68½ pounds	67½ pounds
Crew.....	Machine-gunner, assistant machine-gunner, ammunition carrier	Machine-gunner, assistant machine-gunner, ammunition carrier
Remarks.....	Full automatic or single shot fired in bursts of 7 to 10 rounds as LMG; in 50-round bursts as Hv MG	Full automatic only; cannot fire single shots; fired in bursts of 5 to 7 rounds as LMG; in 50-round bursts as Hv MG

Figure 21.—Characteristics of the *M. G. 34* and *M. G. 42*.



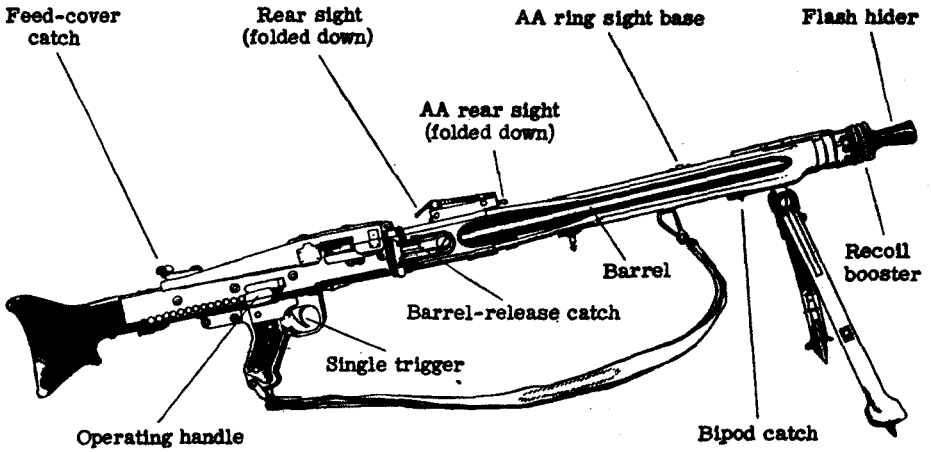

Figure 22.—M.G. 42 on bipod mount.

a higher rate of fire and smaller dispersion than the *M.G. 34*. These guns are the basic weapons of the infantry squad (one per squad), being fired from a bipod as a light machine gun.

These machine guns may also be fired without a mount; mounted on a tripod (fig. 23) for use as a heavy machine gun (there are

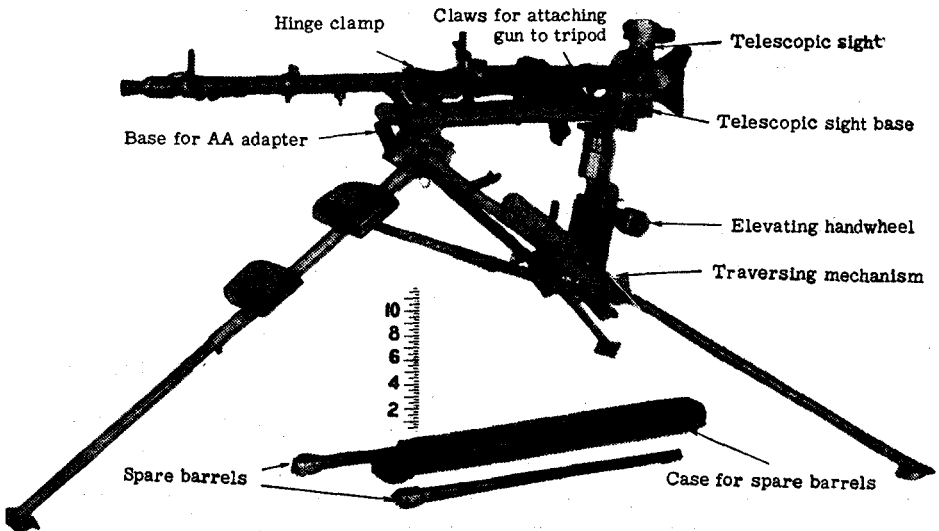

Figure 23.—M.G. 34 on tripod mount.

Type.....	50-mm light mortar, Model 36	81-mm heavy mortar, Model 34
Principle of operation.....	Muzzle loader, fired by trigger	Muzzle loader, fired by firing pin inside breech end of barrel
Sights.....	Line on barrel (tele- scopic sight on early models)	Line on barrel and pano- ramic sight
Range:		
Maximum.....	568 yards	2,625 yards
Minimum.....	55 yards	66 yards
Rate of fire (for short intervals only).....	6 rounds in 8 seconds	6 rounds in 8 to 9 seconds
Ammunition.....	High explosive	High explosive, smoke, indicator (with col- ored smoke)
Weight of projectile.....	2 pounds	7 pounds 12 ounces (all types)
Weight in firing position.....	31 pounds	125 pounds
Traverse.....	600 mils	160 to 265 mils
Crew.....	3 men: Pointer Loader Ammunition carrier	6 men: Mortar commander Pointer Loader 3 ammunition carriers
Remarks.....		Used especially against point of penetration to relieve artillery while the latter lifts fire to more distant targets. Fragmenta- tion effect up to 35 yards.

Figure 24.—Characteristics of the 50-mm and 81-mm mortars.

12 in the heavy-weapons company of the infantry battalion); or mounted on a special antiaircraft mount and used against aircraft by the addition of an adapter and antiaircraft sights.

## 20. INFANTRY MORTARS

The infantry mortar is normally an important support weapon of the German infantry regiment. It was relegated to a minor place in desert fighting because of its limited range (see fig. 24), but its capabilities have been fully exploited in the Tunisian and Italian Campaigns.

The two standard infantry mortars of the German Army are the 50-mm light mortar, model 36 (*leichter Granatwerfer 36*) (fig. 25), and the 81-mm heavy mortar, model 34 (*schwerer Granatwerfer 34*) (fig. 26, p. 42).

The 50-mm mortar is the organic support weapon of the rifle platoon and rifle company (one per rifle platoon), and the 81-mm mortar is the organic support weapon of the infantry battalion (six per battalion, in the heavy-weapons company). A 120-mm mortar is also in use, firing a 35-pound projectile up to 6,500 yards (see par. 13b, p. 27).

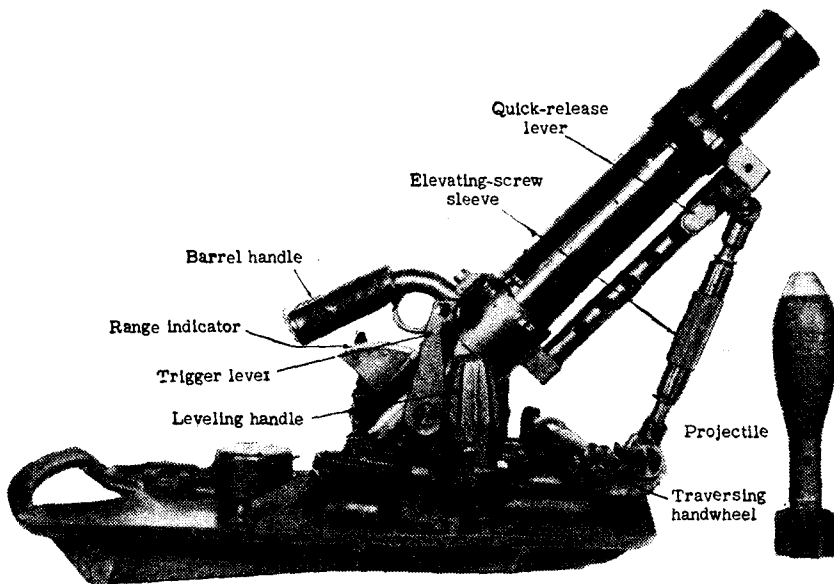
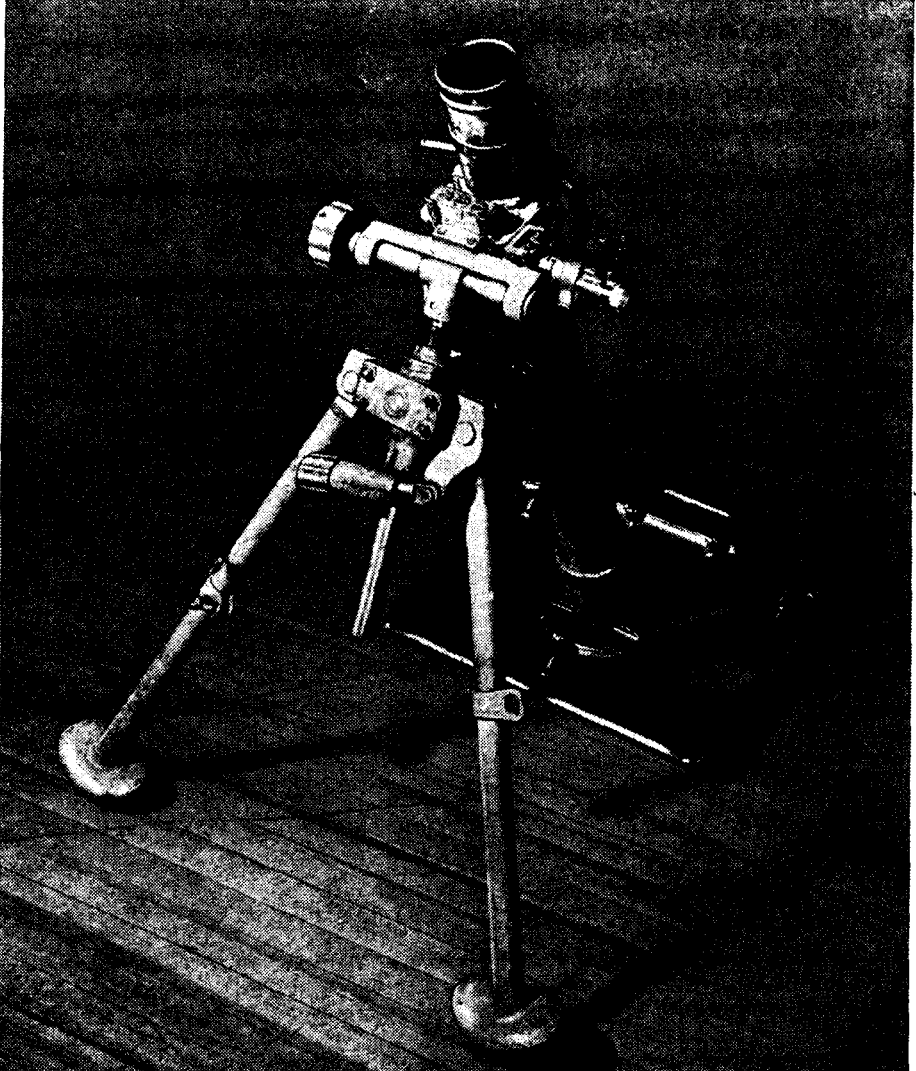

Figure 25.—50-mm mortar, model 36.



**Figure 26.—81-mm mortar, model 34.**

## 21. INFANTRY HOWITZERS

The standard German infantry howitzers are the 75-mm light infantry howitzer, model 18 (*7.5 cm leichtes Infanterie-Geschütz 18*), and the 150-mm heavy infantry howitzer, model 33 (*15 cm schweres Infanterie-Geschütz 33*). (See fig. 27.)

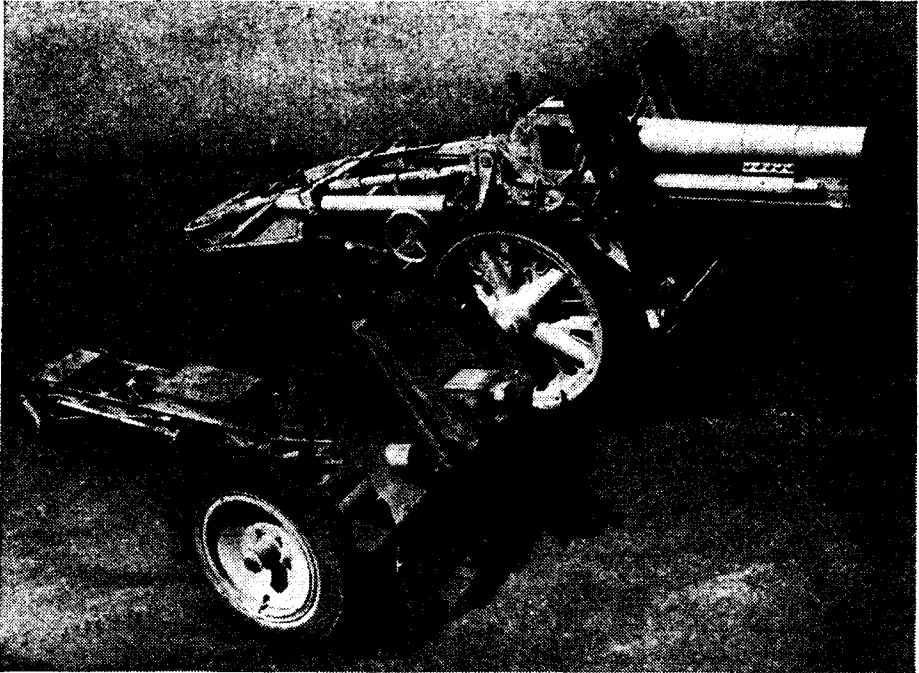

Figure 27.—75-mm (light) and 150-mm (heavy) infantry howitzers (from left to right).

There are six light and two heavy howitzers in the howitzer (13th) company of the German infantry regiment. The light howitzer was introduced in 1934 and the heavy howitzer in 1938. These models have continued in use without substantial change during the present war.<sup>1</sup> (For the principal characteristics of the 75-mm and 150-mm infantry howitzers, see fig. 28, p. 44.)

<sup>1</sup> For operation and technical details, see "German Infantry Weapons," *Special Series*, No. 14 (25 May 1943), pp. 136-160.

Type.....	75-mm light infantry howitzer	150-mm heavy infantry howitzer
German designation.....	7.5 cm <i>le.I.G. 18</i>	15 cm <i>s.I.G. 83</i>
Identification and recognition.....	Pneumatic tires and disk wheels when motorized (steel tires and artillery wheels when horse-drawn); shield with wavy edge; square breech-block and slipper; box trail (mountain howitzer model ( <i>le. Geb. I.G. 18</i> ) has a split trail)	Solid rubber tires (steel tires when horse-drawn); shield; long recoil cylinder under barrel; box trail.
Length of piece.....	10 calibers	11 calibers
Muzzle velocity (maximum)	730 feet per second	790 feet per second
Maximum range.....	3,880 yards	5,140 yards
Rate of fire:		
Maximum.....	15 to 20 rounds per minute	
Normal.....	5 to 10 rounds per minute	5 to 7 rounds per minute
Ammunition.....	Semifixed: high explosive or hollow charge	Semifixed: high explosive, hollow charge, or smoke
Weight of projectile.....	10.6 to 13.2 pounds	83.6 to 85.0 pounds
Penetration.....	3 feet of wood and dirt cover	6 to 10 feet of wood and dirt cover
Fragmentation.....		60 yards laterally, 20 yards forward and 10 yards to rear
Weight in firing position.....	880 pounds	3,360 pounds
Method of transport.....	Horse-drawn, motorized, or pack in six loads	Horse-drawn or motorized
Elevation.....	1,292 mils	1,300 mils
Depression.....	178 mils	None
Traverse.....	212 mils	200 mils
Remarks.....	Breech block opened by depressing muzzle and thus raising breech	Sliding-wedge breech block; also used on self-propelled mount

Figure 28.—Characteristics of the 75-mm and 150-mm infantry howitzers.

## 22. ANTITANK WEAPONS

### a. Normal Weapons

Standard German antitank weapons of regular infantry divisions are designed to obtain maximum penetrations at medium ranges by means of relatively heavy, high-velocity projectiles. To achieve this performance, and in order to provide shields for protection of the gun crews, the Germans have sacrificed some mobility. The sacrifice of mobility was more pronounced as weapons of increasing caliber were introduced. Thus the relatively light 37-mm antitank gun (*3.7 cm Pak*) is now obsolescent, and is being replaced in the antitank company of the infantry regiment (12 guns) and in the division antitank battalion by the heavier 50-mm antitank gun (*5 cm Pak 38*), and lately even by the 3,000-pound 75-mm antitank gun (*7.5 cm Pak 40*) (fig. 29). The development has reached a climax in the extremely heavy 88-mm antitank gun (*8.8 cm Pak 43*) (figs. 30 and 31, p. 46), which has recently been encountered in action. (For the principal characteristics of common antitank weapons, see fig. 32a, p. 47.)



Figure 29.—75-mm, 50-mm, and 37-mm antitank guns (from left to right).



Figure 30.—Front view of the 88-mm antitank gun (8.8. cm Pak 43).

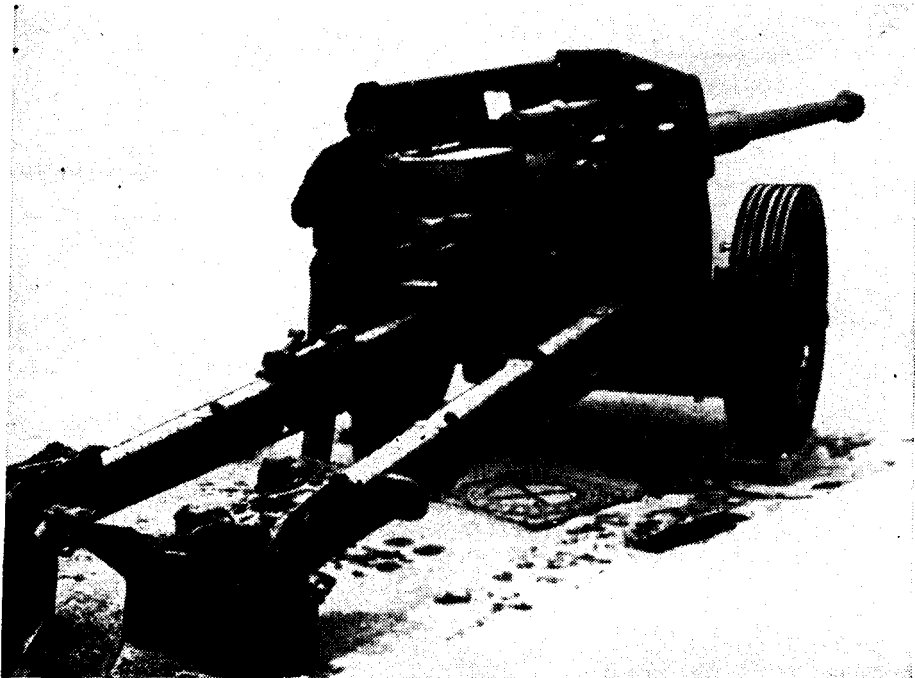

Figure 31.—Rear view of the 88-mm antitank gun (8.8. cm Pak 43).



Weapon.....	Antitank rifle	37-mm antitank gun	50-mm antitank gun	75-mm antitank gun
German designation.....	<i>Pz. B. 38 (or 39)</i>	<i>3.7 cm Pak</i>	<i>5 cm Pak 38</i>	<i>7.5 cm Pak 40</i>
Length of piece....	62½ inches (with shoulder stock in place)	50 calibers	56 calibers	46 calibers
Identification and recognition.....	Bipod, carrying handle, muzzle brake, folding shoulder stock	Angular shield, no muzzle brake, gun mounted very low (below tops of wheels)	Long thin barrel, curved shield, bell-shaped muzzle brake	Angular shield, muzzle brake
Muzzle velocity (maximum).....	3,540 feet per second	2,625 to 3,450 feet per second	2,500 feet per second	3,250 feet per second
Range (effective)...	250 to 300 yards	Up to 600 yards	Against moving tanks, 650 yards; against stationary targets, 1,300 yards	
Rate of fire (normal).....	6 to 8 rounds per minute	8 to 10 rounds per minute	10 to 15 rounds per minute	
Ammunition.....	Armor-piercing with tear-gas charge	Armor-piercing, high-explosive, stick bomb	Armor-piercing, high-explosive	Armor-piercing shot, armor-piercing cap, high-explosive, hollow-charge, smoke
Weight of projectile.....	225 grains	1.37 to 1.68 pounds (stick bomb, 19 pounds)	2 to 4.6 pounds	7.06 to 15 pounds
Armor penetration.....	0.75 inch (19-mm) at 300 yards and normal	1 inch (26 mm) at 600 yards and 30 degrees from normal	At 30 degrees from normal (estimated): 3.11 inches (79 mm) at 300 yards; 2.2 inches (56 mm) at 1,110 yards	At 30 degrees from normal: 4.43 inches (112.5-mm) at 500 yards; 2.87 inches (73 mm) at 2,500 yards
Weight in firing position.....	27¼ pounds	970 pounds	2,000 pounds	3,000 pounds (approximately)
Elevation.....		-140 to +445 mils	-320 to +480 mils	-90 to +390 mils
Traverse.....		1,065 mils	1,155 mils	1,155 mils

Figure 32a.—Characteristics of common antitank weapons.

Weapons	Muzzle velocity (feet per second)	Weight of shell (pounds)	Armor penetration (at 30 degrees from normal) (inches)	Range with high-explosive shell (yards)	Weight of gun (pounds)
<b>German weapons</b>					
28/20-mm tapered-bore gun (s. Pz.B. 41).....	over 5,000	0.2 to 0.28	2.36 at 200 yards		501
42/28-mm tapered-bore gun (4.2 cm le. Pak 41).....	4,100	0.79	2.16 at 1,000 yards 3.03 at 500 yards		800
75/55-mm tapered-bore gun (7.5 cm Pak 41).....	3,936	5.68	3.93 at 1,000 yards 5.74 at 100 yards		3,136
88-mm gun (8.8 cm Pak 43).....	3,729	22	4.40 at 2,500 yards 5.89 at 500 yards	17,500	9,680
<b>Captured weapons</b>					
14.5-mm M41 Degtyarov rifle (Russian).....	3,300	0.14	0.98 at 550 yards 1.06 at 330 yards 1.18 at 110 yards	HE not fired	36.3
14.5-mm M41 Simonov semiautomatic rifle (Russian).....	3,300	0.14	0.98 at 550 yards 1.06 at 330 yards 1.18 at 110 yards	HE not fired	44.7
20-mm Solothurn semi-automatic rifle (Dutch, Italian).....	2,800	0.4	0.70 at 200 yards 0.86 at 100 yards	1,550	110
25-mm Hotchkiss automatic AA/AT (French).....	2,950	0.55 (120 rounds per minute)	1.57 at 400 yards 2.36 at 100 yards	8,200	2,688
45-mm M32 (Russian).....	2,500	1.69		7,700	856
45-mm M36/37 (Russian).....	2,500	1.69		7,700	935
47-mm F.R.C. (Belgian).....	1,980	3.4		7,800	1,100
47-mm Böhler (Italian).....	2,060	3.2	1.45 at 700 yards 1.69 at 500 yards	7,600	600
47-mm Böhler (Austrian).....	2,160	3.2	0.70 at 200 yards 0.86 at 100 yards	7,700	683
47-mm Böhler (Dutch).....	2,160	3.2	0.70 at 200 yards 0.86 at 100 yards	7,500	635
47-mm Schneider M39 (French).....	2,800	3.8	2.36 at 600 yards 3.14 at 200 yards	5,500	2,310
47-mm Skoda.....	2,540	3.68	1.85 at 1,000 yards 2.32 at 300 yards	4,400	(Generally on self-propelled carriage) 2,475
57-mm M41 (Russian).....	3,366	6.83	3.93 at 550 yards	8,800	
75-mm M1897 (French) on German 50-mm carriage (German 7.5 cm Pak 97/38).....	1,890	14.8	2.36 at 880 yards	11,700	2,688
76.2-mm M36 (Russian; German designation, 7.62 cm F. K. 36(r)).....	2,430	16.72	3.26 at 1,000 yards 3.70 at 500 yards	10,936	3,808
76.2-mm M42 (Russian; 76.2-mm M39 field gun on light carriage).....	2,244	13.7		14,300	2,464

Figure 32b.—Characteristics of special and miscellaneous German and captured antitank weapons.

Since standard German antitank guns fire projectiles which are sufficiently large for the use of high explosives, they may also be used against personnel. The number of German antitank weapons assigned to each unit has tended to increase; there also has been an increase in the number of guns mounted on self-propelled carriages.

The antitank rifles, models 38 and 39 (*Panzerbüchse*, or *Pz.B.*, 38 or 39), are the organic antitank weapons of the rifle company (three per company) (fig. 33). When permanently modified for firing standard rifle grenades, model 39 is known as the *Granatbüchse 39* (*Gr.B. 39*). This modification is often found in place of the standard antitank rifle.

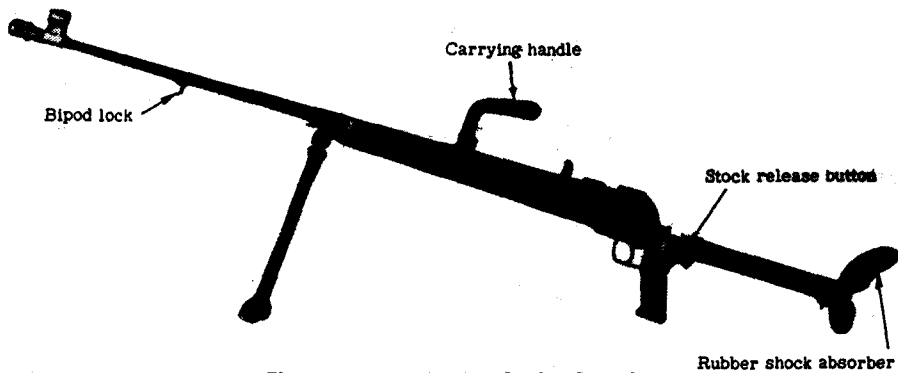

Figure 33.—Antitank rifle (*Pz.B. 39*).



Figure 34.—28/20-mm antitank gun (*s.Pz.B. 41*).

## b. Special and Miscellaneous Weapons

Some special units which require lighter and more mobile anti-tank weapons that are capable of good penetration have been provided by the Germans with several tapered-bore antitank guns. These weapons obtain maximum penetration with light, very high-velocity projectiles at short ranges. They are primarily intended for airborne and mountain divisions, but the 28/20-mm is being used as a rifle-company weapon in organizations like the light (*Jäger*), and panzer-grenadier units (see fig. 34, p. 49). The 28/20 is normally carried on a trailer but it may be broken down into six loads; its parachute version is very light and has two small rubber-tired wheels.

Besides the special antitank weapons, the Germans employ large numbers of the antitank guns of occupied countries. Many of these weapons are issued to German units. However, many of them are retained and used by the units which happen to capture them. (For the characteristics of miscellaneous German and captured antitank weapons, see fig. 32b, p. 48.)

## 23. HEAVY CHEMICAL MORTARS AND ROCKET WEAPONS

Various types and calibers of heavy chemical (smoke) mortars and rocket projectors which were primarily designed for use as chemical-warfare projectors are used as support weapons. The standard chemical mortars (*10 cm Nebelwerfer 35* and *40*), 105 mm in caliber, are similar to an infantry mortar. They fire high-explosive, smoke, or chemical projectiles weighing up to 19 pounds at ranges up to 6,780 yards. Rockets may be fired from barrels, from simple, inclined steel racks, and from vehicles. Common weapons include the 1,200-pound, easily-manhandled 150-mm six-barreled projector (*15 cm Nebelwerfer 41*) (fig. 35); the ten-barreled *15 cm Panzerwerfer 42*, which is mounted on an armored half-track (fig. 36) and fires the same ammunition as the *15 cm Nebelwerfer 41*; the 210-mm five-barreled projector (*21 cm Nebelwerfer 42*); and the *28/32 cm Nebelwerfer 41*, which can fire either 280-mm or 320-mm rockets from each of its six racks, by using appropriate, removable liners. All sizes of projectiles produce large numbers of small, high-velocity fragments. The *15 cm Nebelwerfer 41*, the

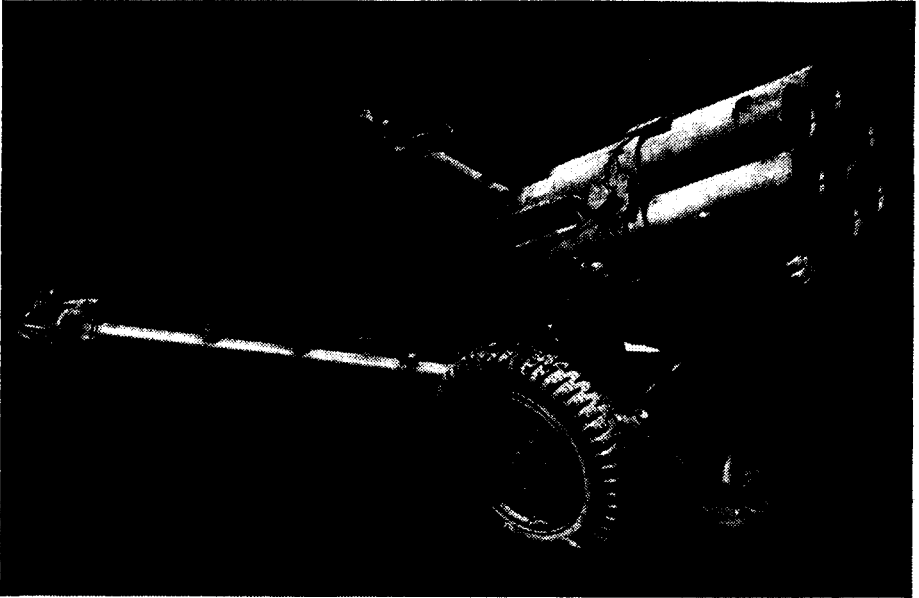

Figure 35.—150-mm six-barreled rocket projector (15 cm *Nebelwerfer 41*). (This projector fires 77- or 78-pound projectiles to a maximum range of 8,600 yards.)



Figure 36.—150-mm ten-barreled rocket projectors (15 cm *Panzerwerfer 42*) in action.

21 cm *Nebelwerfer* 42, and the 28/32 cm *Nebelwerfer* 41 are all mounted on pneumatic-tired carriages resembling those used by artillery weapons. They are generally towed by light half-tracks. Late German rocket weapons include the *Ofenrohr* ("Stovepipe"), a German version of the U.S. "Bazooka," designated as the 8.8 cm *Raketen-Panzerbüchse* 43 (8.8 cm *R.Pz.B.* 43).

Rockets create considerable disturbance at the firing point, raising clouds of dust and smoke. Their trails betray the location of the projector positions. Since crews must take shelter in slit trenches during firing, the normal rate of fire of the 15 cm *Nebelwerfer* 41 is reduced to one salvo in 8 minutes. The 15 cm *Panzerwerfer* 42, however, because its crew can take quick cover within the vehicle, is believed to have a higher rate of fire than the other types of projectors. All types of German launchers have a high proportion of misfires.

## 24. ARTILLERY

### a. General

The standard artillery materiel of the German Army was developed in 1933 or subsequently. In addition to this, some older German materiel and a considerable quantity of captured materiel, especially Polish, French, Czech, and Russian, are in use.

The basic types of German field artillery, which were developed from 1933 to 1939, have continued in use without sweeping changes. These weapons usually have horizontal sliding-wedge breechblocks, fire semifixed ammunition (up to and including 280-mm), and have split trails which permit a field of fire of about 60 degrees. Designs are standardized for maximum interchangeability of parts and equipment. The same carriage is usually used for a gun of one caliber and the howitzer of the next higher caliber. For example, both the 105-mm gun (10 cm *K.* 18) and the 150-mm howitzer (15 cm *le.F.H.* 18) use the same carriage. Light and medium artillery are designed to be either horse-drawn or motorized. Medium artillery may be divided into two loads when horse-drawn. Heavy artillery, always motorized, is usually drawn in two loads.

The chief aim of the Germans in developing new weapons has

been increased fire power and greater mobility. The caliber, muzzle velocity, and armor penetration of antitank guns have increased (especially owing to the development of the Gerlich, or tapered-bore, principle). Antiaircraft guns have been increasingly developed as dual-purpose or, as with the 88-mm antiaircraft gun, multi-purpose weapons). Various types of standard weapons, especially anti-tank, antiaircraft, and infantry support weapons, have been mounted on self-propelled mounts (frequently on obsolete tank chassis). The Germans have also developed rocket weapons requiring the lightest and simplest equipment for the size of the projectile, but limited by inaccuracy and other drawbacks. The German recoilless gun (originally developed as an airborne gun) comes close to combining the lightness and mobility of the rocket weapon with the range and accuracy of the standard type of howitzer.

### **b. Division Artillery**

The standard artillery weapons of the division artillery regiment belong to the "18" series, which was developed about 1933-34. They consist of the 105-mm howitzer (*10.5 cm le.F.H. 18*) (fig. 37) (usually 12 of this weapon in each of the 3 light battalions

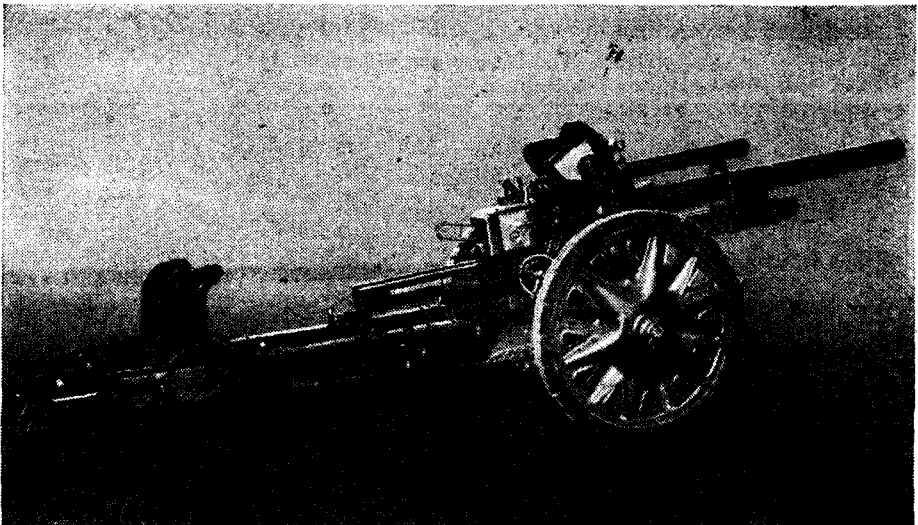

**Figure 37.—105-mm howitzer (10.5 cm le.F.H. 18).**

of the infantry division artillery regiment); the 105-mm gun (*10 cm K. 18*) (fig. 38) (usually 4 of this weapon in the medium battalion of the infantry division artillery regiment); and the 150-mm howitzer (*15 cm s.F.H. 18*) (fig. 39) (usually 8 of this weapon in the medium battalion of the infantry division artillery regiment).

These weapons follow the same general design, with split trails, folding spades, solid rubber tires on light alloy or pressed steel wheels, hydropneumatic counterrecoil and recuperator cylinder above the barrel and hydraulic recoil mechanism below, rear trun-



Figure 38.—105-mm gun (*10 cm K. 18*).

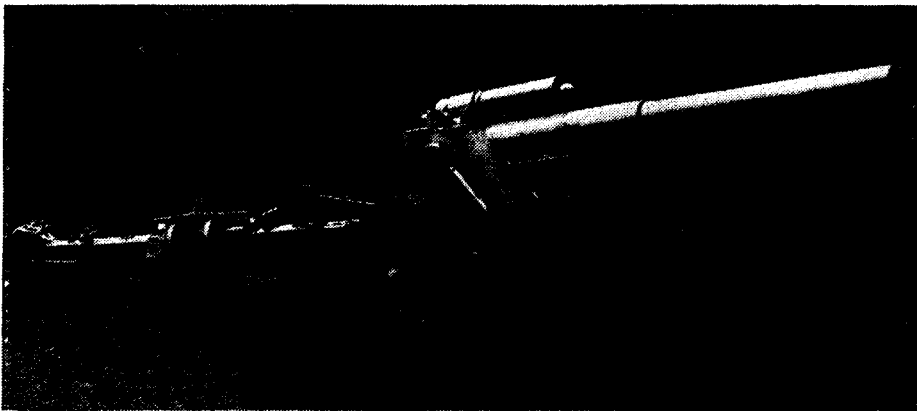

Figure 39.—150-mm howitzer (*15 cm s.F.H. 18*).



Weapon.....	105-mm (light field) howitzer	105-mm (medium field) gun	150-mm (medium field) howitzer
German designation	<i>10.5 cm le.F. H. 18</i>	<i>10 cm K. 18</i>	<i>15 cm s.F. H. 18</i>
Length of piece.....	25.7 calibers	50 calibers	29.5 calibers
Muzzle velocity (maximum).....	1,540 feet per second	2,740 feet per second	1,705 feet per second
Maximum range.....	11,670 yards	20,800 yards	14,570 yards
Rate of fire (normal).....		4 to 6 rounds per minute	4 rounds per minute
Ammunition.....	Semifixed: high-explosive, armor-piercing, smoke, hollow-charge, incendiary	Semifixed: high-explosive, armor-piercing	Semifixed: high-explosive, smoke, anti-concrete
Weight of projectile..	25.6 to 34.8 pounds	32.6 to 34.7 pounds	95.7 pounds
Penetration (at medium ranges)....	With high-explosive: 9 feet of sand and earth; 9 inches of concrete	With high-explosive: 10 feet of sand and earth; 9 inches of concrete	With high-explosive: 13 feet of sand and earth; with anti-concrete shell: 14 inches of concrete
Fragmentation (high-explosive)....	30 to 40 yards laterally, and 10 yards to front	30 to 36 yards laterally; 8 to 10 yards to front	50 to 60 yards laterally; 20 to 23 yards to front; 6 to 7 yards to rear
Weight in firing position.....	4,250 pounds	12,320 pounds	12,320 pounds
Method of transport	Horse-drawn or motorized (sometimes on self-propelled mount)	Horse-drawn or motorized	Horse-drawn or motorized (sometimes on self-propelled mount)
Elevation.....	720 mils	800 mils	800 mils
Depression.....	115 mils	27 mils	27 mils
Traverse.....	995 mils	1,065 mils	1,065 mils
Remarks.....	This weapon is in the light battalion, which is often used in support of an infantry regiment. A recent model equipped with muzzle brake has a range of 13,430 yards	Commonly employed for counterbattery fire	Commonly employed for counterbattery fire

Figure 40.—Characteristics of standard artillery weapons of the division artillery regiment.

nions and equilibrators, monobloc barrel, and horizontal sliding breechblock. They fire semifixed ammunition and use a panoramic sight (*Rbl.F. 32*). Later models of these weapons have been developed, but details are not available. (For the principal characteristics of standard artillery weapons of the division artillery regiment, see fig. 40, p. 55.)



Figure 41.—170-mm gun (17 cm Kanone in Mörser-Lafette 18).

### c. GHQ Reserve Artillery

A considerable amount of artillery, including numerous types for special purposes, is under the control of the GHQ reserve, and is allotted to lower echelons according to their estimated needs. Special types of units include assault-gun battalions and independent assault-gun batteries; motorized Army anti-aircraft artillery battalions; Army coast artillery battalions and railway artillery battalions.

Two of the more common GHQ artillery weapons are the following:

Weapon .....	170-mm gun (fig. 41) .....	210-mm howitzer (fig. 42)
German designation.....	17 cm Kanone in Mörser-Lafette 18.....	21 cm Mörser 18
Maximum range .....	32,371 yards.....	18,263 yards
Maximum elevation .....	890 mils.....	1,230 mils
Weight of projectile .....	138 to 150 pounds.....	249 to 268 pounds

### d. Antiaircraft Guns

Although anti-aircraft defense is primarily under the German Air Force (*Luftwaffe*), certain anti-aircraft units are in the GHQ reserve, and some divisions have organic anti-aircraft defense. The



Figure 42.—210-mm howitzer (21 cm Mörser 18).

Germans call antiaircraft guns *Flak*, an abbreviation of *Flug(zeug)-abwehrkanone*. Antiaircraft guns are especially important to ground troops because, as dual-purpose or multi-purpose weapons, they may be used not only against aircraft but also against ground targets, especially tanks.

German tactical doctrine stresses the importance of mobility in artillery, especially for those weapons used against tanks. The recent trend has been to provide dual-purpose guns of small and medium calibers with self-propelled mounts. The 20-mm gun is also found in a four-barreled mount (*Flakvierling*), which is often on a half-track. German antiaircraft guns exist in various calibers (20-mm, 37-mm, 40-mm, 50-mm, 75-mm, 88-mm, 105-mm, 128-mm, and 150-mm). Of these the 20-mm (fig. 43) (frequently on a self-propelled mount) is the principal light dual-purpose gun, and the 88-mm (fig. 44) the principal heavy dual-purpose gun of ground troops, although the other calibers up to 105-mm are sometimes encountered.

Both the 20-mm and the 88-mm will be encountered in the motorized Army antiaircraft battalion (*Heeresflakartillerieabteilung (mot)*) and the antiaircraft battalion (*Flakbataillon*) of the artillery regiment of the panzer, panzer-grenadier, and Waffen-SS divisions.

The antiaircraft machine-gun battalion (*Fla-Bataillon*) has 20-mm or 37-mm guns in addition to machine guns, and the antiaircraft company of the antitank battalion of some divisions is equipped with 20-mm guns. (For the principal characteristics of common antiaircraft guns, see fig. 45, p. 60.)

## 25. OBSTACLES, LAND MINES, AND BOOBY TRAPS

### a. General

The Germans use obstacles (*Sperren*) as important weapons and tactical aids. The term *Sperren*, as they use it, includes everything that can make the advance of opposing troops more difficult and more dangerous, such as ditches, tank traps, wire, demolitions, mines and booby traps, or some or all of these in combination. *Sperren* are protected by fire from weapons whenever possible.

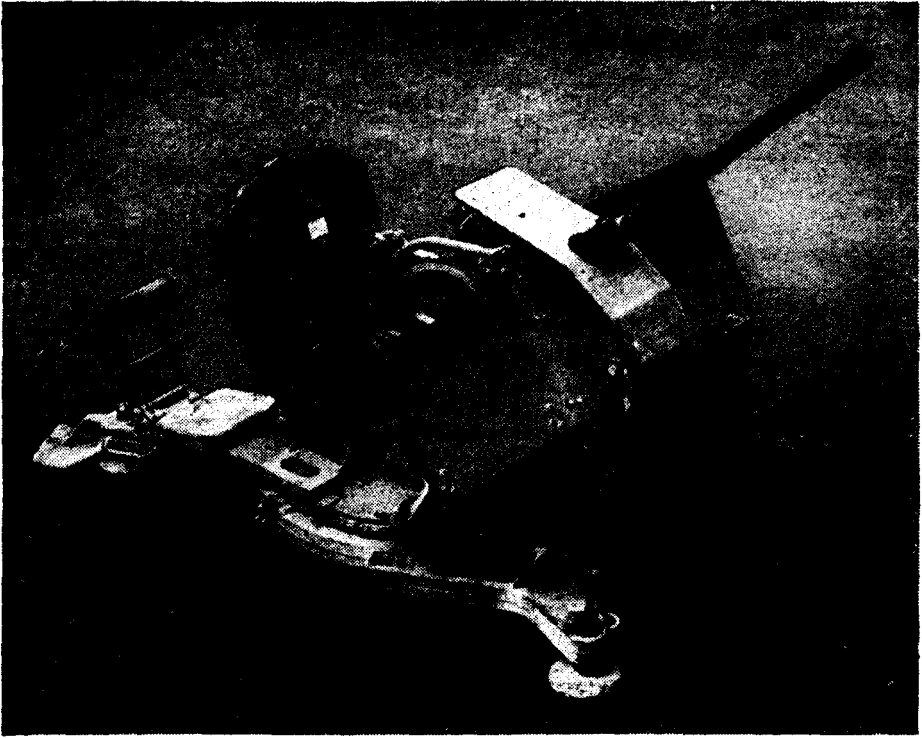

Figure 43.—20-mm dual-purpose gun (2 cm Flak 38).



Figure 44.—88-mm dual-purpose gun (8.8 cm Flak 18).

Weapon.....	20-mm, Model 38	37-mm, Models 36 and 37	88-mm, Models 18, 36, and 37
German designation	<i>2 cm Flak 38</i>	<i>3.7 cm Flak 36 and 37</i>	<i>8.8 cm Flak 18, 36, and 37</i>
Length of piece.....	65 calibers	50 calibers	56 calibers
Identification and recognition.....	Long thin barrel, bell-shaped muzzle brake	Long thin barrel, bell-shaped muzzle brake	Recuperator and counter-recoil mechanism above barrel, recoil mechanism below barrel; long rammer and tray rear of breech block; double equilibrators in horizontal position forward of trunnions and below barrel; square shield for dual-purpose use
Muzzle velocity	2,600 to 2,950 feet per second	2,400 to 3,550 feet per second	1,970 to 3,050 feet per second
Maximum horizontal range.....	5,250 yards	7,100 yards	16,200 yards
Effective vertical range.....	6,500 feet	13,775 feet	34,770 feet
Rate of fire (normal).....	180 to 220 rounds per minute	80 to 120 rounds per minute	15 to 20 rounds per minute
Ammunition.....	High-explosive, incendiary, armor-piercing, tracer	High-explosive, armor-piercing, tracer	High-explosive, armor-piercing, armor-piercing cap, hollow-charge
Weight of projectile.....	3.55 to 5.16 ounces	0.79 to 1.88 pounds	16.0 to 20.75 pounds
Armor penetration (at 870 yards and 30 degrees from normal).....	Up to 0.47 inch (12 mm)	Up to 0.98 inch (25 mm)	Up to 4.33 inches (110 mm)
Weight in firing position.....	900 pounds	3,400 pounds	10,000 pounds
Method of transport.....	Truck-drawn or mounted on half-track	Truck-drawn or mounted on half-track	Drawn by half-track
Elevation.....	-355 to +1,600 mils	-180 to +1,510 mils	-55 to +1,1510 mils
Traverse.....	6,400 mils	6,400 mils	6,400 mils
Remarks.....	Model 30 substantially similar, but with lower rate of fire	Model 18 substantially similar	Model 41 similar in general, but has a longer barrel, is mounted lower, and has superior performance

Figure 45.—Characteristics of common antiaircraft guns.

## b. Land Mines

Both antitank and antipersonnel mines are laid at every opportunity. Avenues of approach, roads, road shoulders, crossroads and road junctions, turnouts, parking areas, ditches, and culverts are often mined. Prepared positions are usually protected by mine fields. These mine fields may be laid in belts of various types of antitank and antipersonnel mines. Antipersonnel mines are scattered in any area in front of a German position which is favorable for the concentration or passage of opposing troops.

The two most common types of mines are the **T**-mine (*Tellermine*) (fig. 46), an antitank mine, and the **S**-mine (*Schrapnellmine*) (fig. 47, p. 62), popularly known as the "Bouncing Baby," an antipersonnel mine. The **T**-mine can disable a tank by blowing its tracks off. The **S**-mine, when set off by being stepped on or by trip wires, leaps about 3 to 7 feet in the air and scatters a charge of about 320 steel balls, together with fragments of the case, in every direction up to 200 yards. Although the **T**-mine will not



Figure 46.—Antitank mine (*Tellermine* 43). (This mine has a steel case painted gray. It weighs 18 pounds, including 12 pounds of TNT. Other types of antitank mines resemble it in general.)

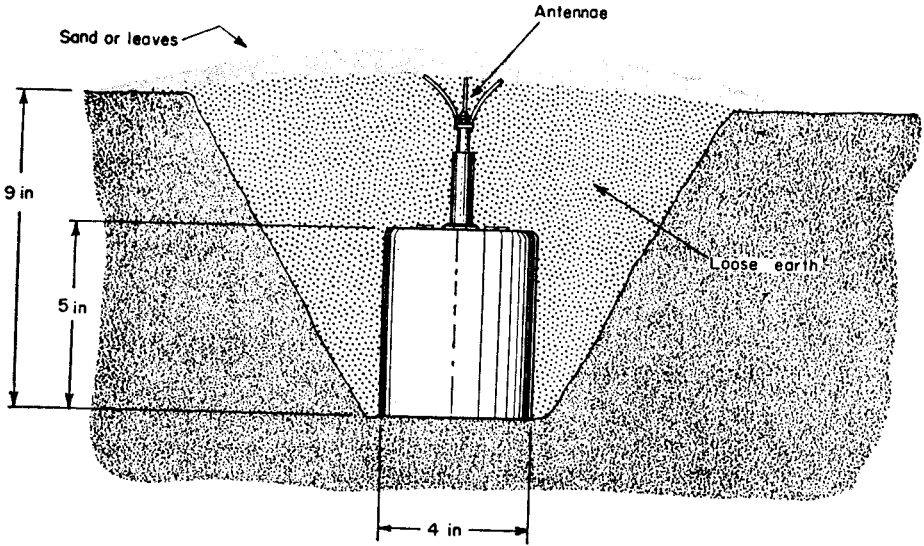

①

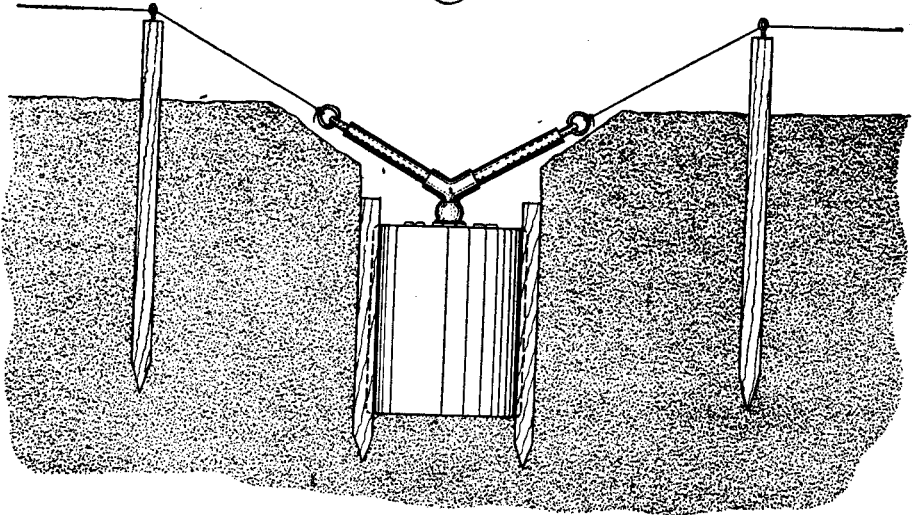

②

Figure 47.—Antipersonnel mine (*Schrapnellmine*):

① laid with pressure igniter;

② laid with pull igniter and trip wires.



usually go off under the weight of a man, it sometimes does. **S**-mines are frequently planted on the forward edge of a belt of **T**-mines; they are also interspersed, together with booby traps, within a mine field.

Wooden box mines, concrete antipersonnel mines, and other types of mines are also used.<sup>1</sup>

### **c. Booby Traps**

Making every effort to obtain deception and surprise, the Germans plant booby traps in paths, passages, doorways, windows, drawers, and cabinets—connect them with any movable object or anything that may be stepped on or sat on, and hide them in many ingenious ways in unexpected places. German booby traps may be made from hand grenades, mines, shells, or explosive charges, and actuated by pressure, pull, or time fuzes.

## **26. ARMORED VEHICLES AND SELF-PROPELLED GUNS**

### **a. Tanks**

The German tank (*Panzerkampfwagen*, or *Pz.Kpfw.*)<sup>2</sup> has been made in six series, *I*, *II*, *III*, *IV*, *Panther*, and *Tiger*. The *Pz.Kpfw. I* is obsolete and the *Pz.Kpfw. II* nearly so. The *Pz.Kpfw. III* has been the principal tank of the panzer regiment of the panzer division, but there appears to be a trend to replace the *Pz.Kpfw. III* and even the *Pz.Kpfw. IV* with the *Pz.Kpfw. Panther* and *Tiger* as these later models become available. (For illustrations and details, see figs. 48 to 54, pp. 64 to 67.)

---

<sup>1</sup> For more detailed information on German mines, see FM 5-31, *Land Mines and Booby Traps* (November 1943).

<sup>2</sup> The Germans have abandoned the older abbreviation *Pz.Kw.*, because of possible confusion with the abbreviation for *Personenkraftwagen* (*Plkw.*).

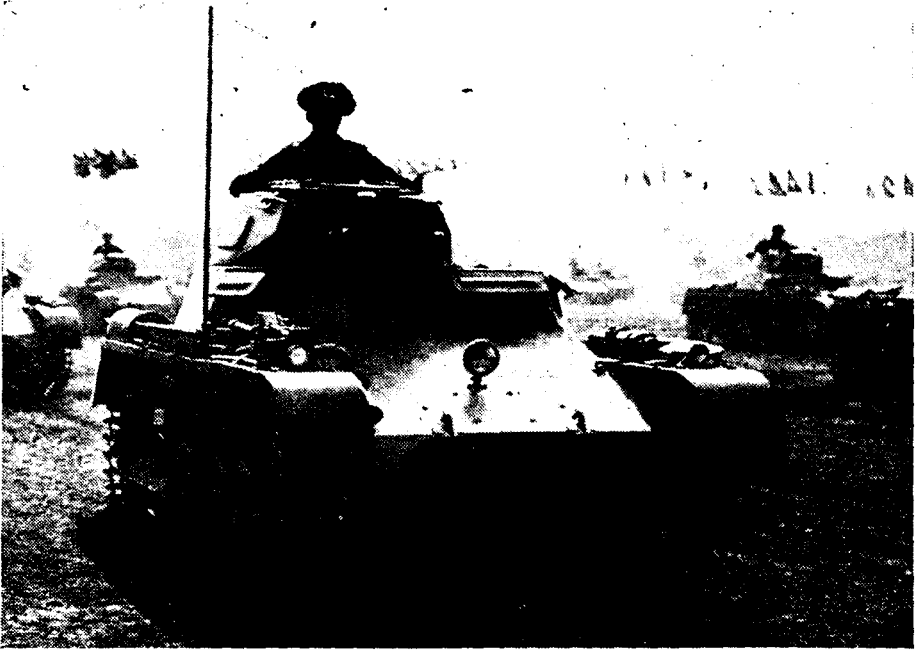

Figure 48.—Pz.Kpfw. I. (Weight, 6.4 tons; maximum speed, 25 miles per hour; armament, two 7.92-mm machine guns in turret; now obsolete.)

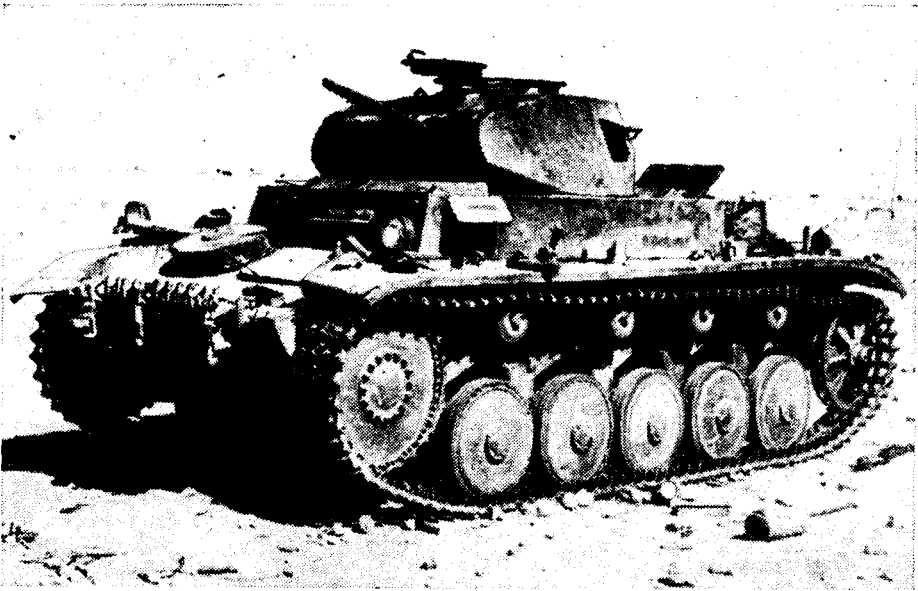

Figure 49.—Pz.Kpfw. II. (Weight, 11.2 tons; maximum speed, 30 miles per hour; armament, one 20-mm tank gun (2 cm Kw.K. 30 or 38) and one 7.92-mm machine gun in turret; now obsolescent; often used by engineers and for flame throwers).

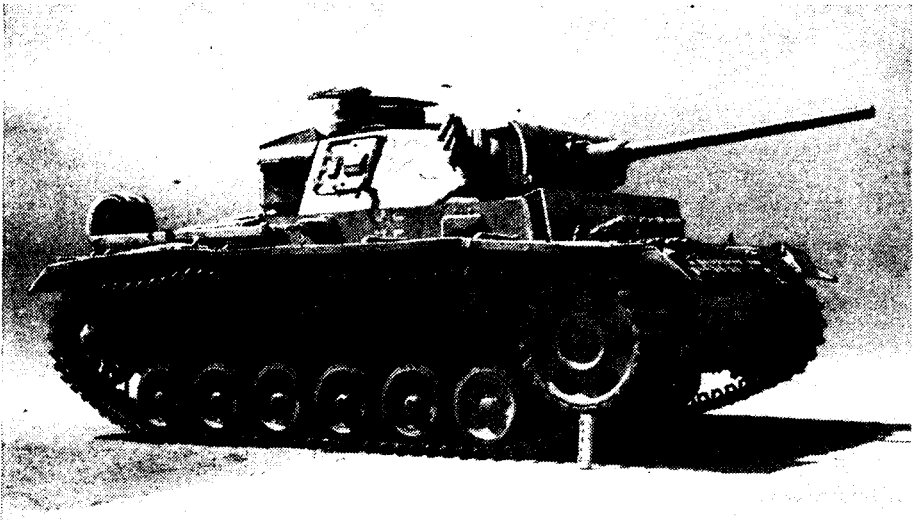

Figure 50.—Pz.Kpfw. III (with 50-mm long-barreled tank gun). (Weight, 24.7 tons; maximum speed, 28 miles per hour; armament, one 50-mm long-barreled tank gun (5 cm Kw.K. 39) or one 75-mm short-barreled tank gun (7.5 cm Kw.K.), and one 7.92-mm machine gun in turret, and one 7.92-mm machine gun in hull.)



Figure 51.—Pz.Kpfw. IV (with 75-mm long-barreled tank gun). (Weight, 26 tons; maximum speed, 25 miles per hour; armament, one 75-mm short-barreled tank gun (7.5 cm Kw.K.) or one 75-mm long-barreled tank gun (7.5 cm Kw.K. 40), and one 7.92-mm machine gun in turret, and one 7.92-mm machine gun in hull.)



Figure 52.—Pz.Kpfw. Panther. (The present model, which is the newest of the German tanks, has been in action on the Russian front. Weight, 50.5 tons; maximum speed, 30 miles per hour; armament, one 75-mm super-long-barreled tank gun (7.5 cm Kw.K. 43) and one 7.92-mm machine gun in turret.)

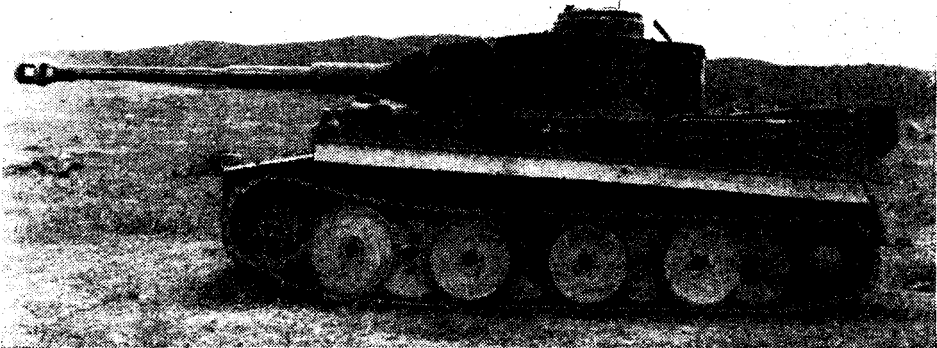

Figure 53.—Pz.Kpfw. Tiger. (Weight, 62.5 tons; maximum speed, 25 miles per hour; armament, one 88-mm super-long-barreled tank gun (8.8 cm Kw.K. 36) (a tank gun version of the 8.8 cm Flak 36) and one 7.92-mm machine gun in turret, and one 7.92-mm machine gun in hull.)



Figure 54.—Armor skirting on a *Pz.Kpfw. IV*. (with 75-mm short-barreled tank gun). (The *Pz.Kpfw. III* and *IV* now carry 5-mm (0.2-inch) plates outside their turrets and outside their suspension. The purpose of these plates is to detonate hollow-charge projectiles and to nullify the effect of antitank rifles. When not in battle, the plates over the suspension may be unbolted and stacked on the rear of the tank.)

## b. Armored Cars and Half-tracks

The standard light armored car (*le.Pz.Sp.Wg.*) has four wheels and the standard heavy armored car (*s.Pz.Sp.Wg. (8-Rad)*) has eight wheels. Each is normally armed with a 20-mm gun and a 7.92-mm machine gun. Many eight-wheeled cars now mount a 75-mm short-barreled tank gun (*7.5 cm Kw.K.*) (fig. 55, p. 68). The six-wheeled heavy armored car (*s.Pz.Sp.Wg. (6-Rad)*) is now obsolete. Armored half-tracks are used as weapons and personnel carriers, as mounts for light weapons, as command vehicles, as ammunition carriers, and as armored observation posts.

## c. Self-propelled Weapons

Many types and calibers of standard weapons, including assault, dual-purpose, and antitank guns, infantry support weapons, and rocket projectors are used on self-propelled mounts, often by installing a standard weapon on an obsolete tank chassis. The *Pz.Kpfw. I* and *II* tanks, the French *Somua* medium tank, and the Czech



Figure 55.—Eight-wheeled armored car (with 75-mm short-barreled tank gun). (The car has been captured and reconditioned by U.S. troops.)

L.T.H. (*Pz.Kpfw. 38 (t)*), a light tank with Christie-type wheels, have frequently been used for this purpose. Antitank and assault guns in particular are given greater mobility by the self-propelled mount. It is German tactical policy to avoid using tanks against tanks, but to use antitank guns against tanks, developing such self-propelled weapons as the *Ferdinand* for this purpose. Among common types of self-propelled guns are the 88-mm antitank guns (the Hornet (*Hornisse*) on a *Pz.Kpfw. IV* chassis and the *Ferdinand* on a *Tiger* chassis); the assault gun (75-mm long-barreled or short-barreled gun or 105-mm howitzer on a *Pz.Kpfw. III* chassis); the 105-mm howitzer on a *Pz.Kpfw. II* chassis, the Wasp (*Wespe*); the 150-mm howitzer on a *Pz.Kpfw. IV* chassis, the Bee (*Hummel*); and the 20-mm dual-purpose gun (either single- or four-barreled), which is frequently mounted on a half-track vehicle. Antitank and assault guns are not mounted in revolving turrets and usually can fire forward only. (See figs. 56 and 57.)

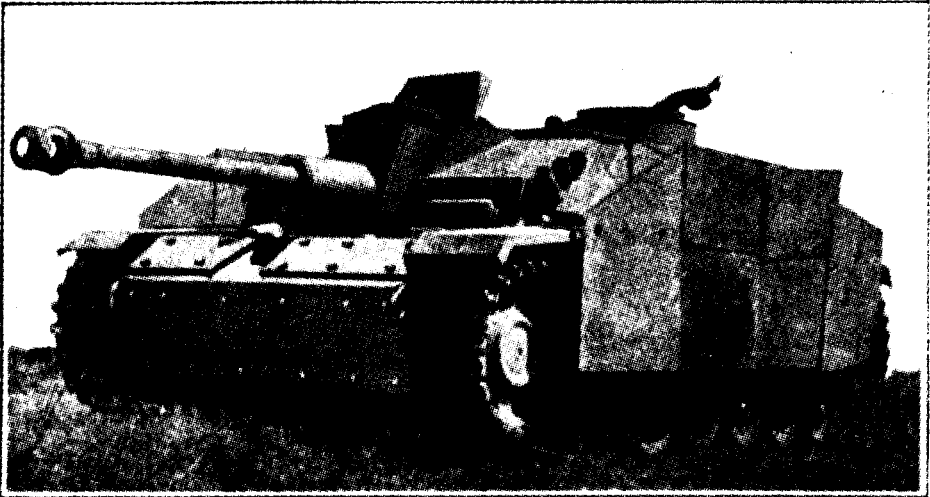

Figure 56.—75-mm assault gun (7.5 cm Sturmkanone, or *Stu.K.*, 40). (This gun, with a range of 8,400 yards, is mounted in the hull of a *Pz.Kpfw. III* tank with the turret removed; additional 1.18-inch (30-mm) plates are bolted on the front, and 0.2-inch (5-mm) skirting plates on the sides. Earlier models lacked the commander's cupola.)



Figure 57.—88-mm self-propelled antitank gun (*Pz.Jäg. Tiger-P (Ferdinand)*). (Weight, 80 tons (approximately); maximum speed, 12 miles per hour; armament, 88-mm tank gun believed to be similar to the 8.8 cm *Flak 41*.)

## Section V. COMBAT TEAMS

---

### 27. GENERAL

A high degree of flexibility is a characteristic of German organization, and it is best exemplified in the fluid composition of combat teams, or "battle groups" (*Kampfgruppen*). Consequently, German tables of organization, though useful for a basic understanding of unit strength, are of little practical value for operational purposes. A German division, whether it is on the offensive or the defensive, is organized into one or more combat teams. While it is important to establish the order of battle of each German division as it is engaged, it is even more important to determine its disposition by teams.

In the German conception, an infantry combat team may vary in size from a reinforced rifle company to a reinforced regiment. Normally, however, a team consists of a regiment of infantry, a battalion of artillery, an engineer unit, and an antitank-antiaircraft detachment. Divisions that include tanks will attach tanks by companies or battalions to combat teams. Sometimes troops of different divisions are mingled in forming a team, units from one team may be transferred to another, or a team may be dissolved and its components assigned to the remaining teams in the division.

The flexible character of a German combat team is further emphasized by the fact that it is normally identified by the name of its commanding officer (see fig. 58, p. 73) rather than by the designation of its principal unit. Although the components of a team may change considerably within a short time, its designation does not change until its commanding officer is relieved or reassigned, or until the team is dissolved. It cannot be assumed, therefore, that the strength and fire power of a German combat team remains constant over a period of days merely because its designation remains unchanged.

The flexibility typical of the infantry combat team is applied in forming combat teams with the infantry (panzer-grenadier) and tank components of the German armored divisions. In the armored division the team is likely to consist approximately of one infantry



regiment, two tank battalions, two light-artillery batteries, two batteries of 88-mm antiaircraft guns, one engineer company, and two antitank companies. As in the infantry divisions, the Germans do not hesitate to mingle, if necessary, the troops of more than one division in organizing an infantry-tank team.

Despite differences in composition, most German combat teams have three elements in common: assault, support, and holding elements. However, teams formed for purely defensive missions may lack the assault element.

When the situation allows adequate time for forming teams, they are likely to be strong, well-balanced organizations. Teams formed to meet sudden emergencies are improvised with less discrimination and may lack self-sufficiency; in battle the quality of their performance may reflect difficulties due to dispersion, attrition, and inability to bring up adequate reinforcements or replacements.

## 28. COMBAT TEAMS IN SICILY

During the Sicilian Campaign the combat teams of the Hermann Göring Panzer Division included troops from the 15th Panzer-Grenadier Division, the 1st Parachute Division, march battalions,<sup>1</sup> and Italian units. Sometimes two combat teams, though retaining their separate identities, are grouped under a single commander. The table in figure 58, page 73, shows the organization of the combat teams of the Hermann Göring Division on 16 July 1943. The changes that occurred within 5 days are shown in figure 59, page 74, which is a German chart dated 21 July 1943.

The German method of forming and reorganizing these teams is demonstrated in the following excerpt from an order dated 16 July 1943:

*Regrouping.* The following will be brought up and employed as whole battalions: 923d Fortress Battalion to Combat Team Öhring, Oria Panzer-Grenadier Battalion to Combat Team Hahm, Reggio Battalion to Combat Team Rebholz. Combat Team Fährmann will be dissolved as soon as a second company of Oria Battalion arrives at Combat Team Hahm.

---

<sup>1</sup> A march battalion (*Marschbataillon*) is a temporary organization used for transferring replacements to a combat zone, but in emergencies the Germans have sent march battalions into combat as units.

Regrouping will proceed in the following manner:

1st Company, 923, will be sent forward by Division to Combat Team Öhring by midday 16 July. When it arrives, the company of Oria already under command<sup>2</sup> will be sent off (on 16 July) to Combat Team Hahm. When this company arrives at Combat Team Hahm, Combat Teams Fährmann and Hartmann will be dissolved. The company of 923d still with Combat Team Hahm will be sent off to Combat Team Öhring. Machine-gun company of Oria Battalion will be sent up to Combat Team Hahm by Division. This regrouping must be accelerated so that the units may be collected under their commanding officers as formed bodies as soon as possible.

Hermann Göring Panzer Engineer Battalion will be released by Combat Team Öhring and collected as division reserve in the area Adriano-Centuripe. Assembly must be completed by early 17 July. The commanding officer of the panzer engineer battalion will act as engineer officer of the division from 17 July.

One battery of the anti-aircraft battalion designated for special employment will be put under command of each of the Combat Teams Öhring, Hahm, and Rebholz to assist in ground and anti-aircraft defense in the forward area, and for anti-aircraft defense of the tanks. Their employment as anti-aircraft on rear communications is forbidden.

The composition of the combat teams shown in figure 59 began to take shape before 19 July. It was on this date that Headquarters, Hermann Göring Tank Regiment, formed Combat Team Preuss, which consisted of a grouping of Combat Teams Kluge and Rebholz under one commander (see fig. 59). An order dated 19 July indicated that the 1st Battalion, Hermann Göring Tank Regiment, was already in division reserve; the Hermann Göring Panzer Engineer Battalion, which had been in division reserve, was assigned to occupy a strongpoint. The 1st Battalion of the 1st Panzer Grenadier Regiment, which appears in Combat Team Hahm in figure 58, did not appear in the chart prepared on 21 July (fig. 59). An explanation of this and other changes is contained in the following excerpt from an order dated 20 July:

To restore coherency among the units, the following changes will be carried out: 1st Battalion, 1st Panzer Grenadier Regiment, will be dissolved, and personnel, weapons, equipment, and motor transport will be taken over by 1st Battalion, 2d Panzer Grenadier Regiment. In the same way regimental headquarters, 2d Panzer Grenadier Regiment, will be taken over by 1st Battalion, 2d Panzer Grenadier Regiment. 2d Battalion, 2d Panzer Grenadier Regiment, will be dissolved and in-

---

<sup>2</sup> That is, under command of Öhring.

Combat team	Infantry and reconnaissance units	Hermann Göring Tank Regiment	Hermann Göring Artillery Regiment	Hermann Göring Flak Regiment
Combat Team Öhring.....	923d Fortress Battalion	1st Battalion	Regimental Headquarters; 13th Battery (smoke); 4th Battalion (mixed)	5th Battery (from an attached battalion)
Combat Team Fahn.....	Regimental Headquarters, 2d Panzer-Grenadier Regiment; 1st Battalion, 1st Panzer-Grenadier Regiment; Oria Panzer Grenadier Battalion; one Italian battalion	Regimental Headquarters, and 2d Battalion	1st Battalion	10th Battery (from an attached battalion)
Combat Team Rebholz.....	Panzer Reconnaissance Battalion <sup>1</sup> ; 2d Battalion, 2d Panzer - Grenadier Regiment; Reggio Battalion <sup>2</sup>		One Italian battalion; 2d Battery (mixed)	9th Battery (from an attached battalion)
Combat Team Schmalz.....	Brigade headquarters (specially organized); Kôrber Regiment (later designated 115th Panzer-Grenadier Regiment); one parachute battalion; Grosse Battalion; one Italian battalion; elements of 3d Parachute Regiment (withdrawing for relief); 1st Battalion, 2d Panzer-Grenadier Regiment	3d Battalion (assault guns)	3d Battalion; one Italian battalion	Catania Flak
Division Reserve.....	Hermann Göring Panzer Engineer Battalion			

<sup>1</sup> The Panzer Reconnaissance Battalion consisted of the following companies: motorcycle rifle, *Volkswagen* (Jeep), armored car, antitank, and light anti-aircraft.

<sup>2</sup> The Reggio Battalion formerly was the 69th Marschbataillon.

Figure 58.—Combat teams based on the Hermann Göring Panzer Division (as of 16 July 1943).

Combat team	Infantry and reconnaissance units	Hermann Göring Tank Regiment	Hermann Göring Artillery Regiment	Hermann Göring Flak Regiment
Combat Team von Carnap (originally Combat Team Öhring)	1st Battalion, 3d Parachute Regiment; 923d Fortress Battalion		13th Battery (smoke); 4th Battalion (mixed)	5th Battery (from an attached battalion)
Combat Team Preuss.		Headquarters and 2d Battalion		Gerbini Flak
(a) Combat Team Kluge	Headquarters and 1st Battalion, 2d Panzer-Grenadier Regiment; Oria Panzer-Grenadier Battalion; one Italian battalion; remnants, 1st Battalion, 1st Panzer-Grenadier Regiment		1st Battalion (150-mm How); one Italian battalion	10th Battery (from an attached battalion)
(b) Combat Team Rebholz	Panzer Reconnaissance Battalion (less one company); Reggio Battalion; remnants, 2d Battalion, 2d Panzer-Grenadier Regiment		2d Battalion	9th Battery (from an attached battalion)
Combat Team Schmalz	Brigade headquarters (specially organized); 115th Panzer-Grenadier Regiment (formerly Körner Regiment); Schachtleben Battalion; 4th Parachute Regiment; 2d Battalion, 382d Panzer-Grenadier Regiment; 904th Fortress Battalion; one Italian battalion	3d Battalion (assault guns)	3d Battalion; one Italian battalion	
Division Reserve	3d Parachute Regiment (less one battalion)	1st Battalion		1st Battalion

Figure 59.—Combat teams based on the Hermann Göring Panzer Division (as of 21 July 1943).

corporated in the Panzer Reconnaissance Battalion. The Panzer Reconnaissance Battalion will use its new details to form a fourth (rifle) company, replenish the 3d Company, and enroll specialists in the 5th and 6th Companies.

The Headquarters personnel of the dissolved units will be formed into "organizational staffs," strength up to 15, with three motor trucks each, under command of an officer. These staffs will include all personnel necessary for winding up the affairs of the unit—clerks, specialist noncommissioned officers, armorers, etc.

By 29 July 1943 the evacuation of Sicily had begun, and the Germans, fearing amphibious operations behind their lines, formed Combat Team Paulus. Its mission was to prevent landings on the favorable beach in the Fiumefreddo area. The composition of this team, which was named after the commanding officer of the 1st Company, Panzer Reconnaissance Battalion, was as follows:

- 1st Company, Panzer Reconnaissance Battalion;
- One battery, 2d Battalion, 33d Artillery Regiment (170-mm guns);
- 9th Company, 1st Panzer Grenadier Regiment;
- Alarm Company<sup>3</sup>, 1st Battalion, Hermann Göring Tank Regiment;
- One Company, 1st Battalion, Hermann Göring Tank Regiment (with eight mixed tanks);
- A special company (less engineer platoon), assigned by division headquarters (the engineer platoon was assigned to Headquarters Company);
- One battery antiaircraft artillery (88-mm guns).

## 29. COMBAT TEAMS IN ITALY

### a. General

The following lists show the organization and missions of some German combat teams which have been employed during the present campaign on the Italian mainland. Information on the fire power of two of the groups was available and has been included.

---

<sup>3</sup> Alarm companies consisting of dismounted tank crews were employed as an infantry reserve by Headquarters, Hermann Göring Tank Regiment. An order of the Hermann Göring Panzer Division, dated 21 July 1943, for the withdrawal from combat of certain units, directed that they be replaced by alarm companies assembled as a panzer alarm battalion.

### b. Combat Team Viebig

Combat Team Viebig was organized for a holding and delaying mission in a favorable defensive sector where little infantry was available. Its component units were as follows:

26th Reconnaissance Battalion;  
8th Company, 26th Tank Regiment;  
1st Company, 93d Engineer Battalion;  
1st Battalion, 93d Artillery Regiment (less 3d Battery, plus 8th Battery);  
3d Battery, 304th Flak Battalion.

### c. Combat Team Heilmann

The mission of Combat Team Heilmann was to conduct a vigorous and protracted delaying action in northern Apulia. It retained its identity for several weeks, and its component units were as follows:

<i>Unit</i>	<i>Officers</i>	<i>Enlisted men</i>
3d Parachute Regiment.....	17	517
11th and 14th Companies, 1st Parachute Regiment..	9	295
10th and 11th Companies, 1st Parachute Artillery Regiment .....	3	167
One platoon (self-propelled guns), 6th Company, 1st Parachute Antitank Battalion.....	1	15
Hoffman Antitank Platoon, Parachute Antitank Battalion .....	1	12
Bauer Antitank Platoon, Parachute Antitank Battalion .....	None	24
Parachute Antiaircraft Machine-gun Battalion.....	(?)	(?)
2d Company, 33d Engineer Battalion.....	2	123
Schindler Flak Battery.....	1	65
Volkman Flak Battery.....	1	37
Sardinia Antitank Platoon.....	1	23
Italian parachutists .....	8	24
<b>TOTAL .....</b>	<b>44</b>	<b>1,302</b>

The fire power of Combat Team Heilmann was as follows:

Antitank guns: One 37-mm, four 42-mm, two 50-mm, six 75-mm, and three 75-mm self-propelled guns.

Antiaircraft guns: Three 20-mm and two 88-mm guns.

Field artillery: None.

Tanks: None.

**d. Combat Team Rau**

Combat Team Rau was formed in an emergency for the defense of the Termoli area. Its composition, strength, and weapons are shown in the following table:

<i>Unit</i>	<i>Officers</i>	<i>Enlisted men</i>	<i>Weapons</i>
Headquarters Battery, 3d Battalion, and 3d Battery, 1st Parachute Artil- lery Regiment.....	4	44	Two 105-mm guns and three light machine guns.
Headquarters Company, Parachute Engineer Battalion .....	1	68	Three heavy machine guns and one heavy mortar.
2d Company, Parachute Engineer Bat- talion .....	1	85	Nine heavy machine guns.
1st Company, Parachute Medical Unit	3	100	Seven light machine guns.
Elements, 3d Battery and 1st Battery, 851st Antiaircraft Battalion, and 327th Antiaircraft Battalion.....	3	69	Two light machine guns; three 20-mm, two 37-mm, and one 88-mm antiaircraft guns.
Kurz Unit.....	—	5	One 75-mm self-pro- pelled gun.
<b>TOTAL</b> .....	<b>12</b>	<b>371</b>	

## Section VI. ORGANIZATION DATA

---

### 30. INFANTRY DIVISION: REORGANIZATION TREND

There is evidence that the German Army is reorganizing its infantry division. The reasons for this trend are a manpower shortage due to attrition, the necessity for preparing for a two-front war, and, possibly, new tactical concepts. The possibilities are that the number of battalions in the infantry regiment will be reduced from three to two, or that the regiments themselves will be reduced within the division from three to two. As a result, the average strength of the division will be reduced to approximately 13,000 officers and enlisted men. It is probable also that the number of squads in the rifle platoon will be reduced from four to three. A consequence of this reduction may be a sizable reduction of the strength of special troops, artillery, and services. There are indications also that the reconnaissance battalion and the antitank battalion may be merged in one mobile battalion.

The exigencies of warfare on the Eastern Front compelled the Germans, in the winter of 1941-42, to organize special ski units for counterattack, patrolling, and defense against guerrilla warfare. These units were GHQ troops and were known originally as *Jagd-kommandos* (raiding detachments), but now they are called *Jäger* battalions. To carry out the same kind of combat missions, the infantry divisions formed provisional battalions patterned on the GHQ ski battalions. Both the GHQ and the provisional battalions evidently proved satisfactory, and after the winter season the Germans decided to retain them as shock troops. They were then motorized in order to preserve their mobility. In forming these units, the composition of the division is altered as little as possible.

The provisional units have now acquired the designation of *Divisions-Bataillons* (divisional battalions), and their primary mission is counterattack. It is likely that they will be employed very flexibly for rapid employment by the division commander to meet critical situations. The divisional battalion consists of three companies of picked riflemen and one heavy-weapons company. In some divisions this unit may replace the reconnaissance battalion.



**31. INFANTRY DIVISION: TABLES OF ORGANIZATION**  
**a. Infantry Division (Infanteriedivision): Organization Chart**

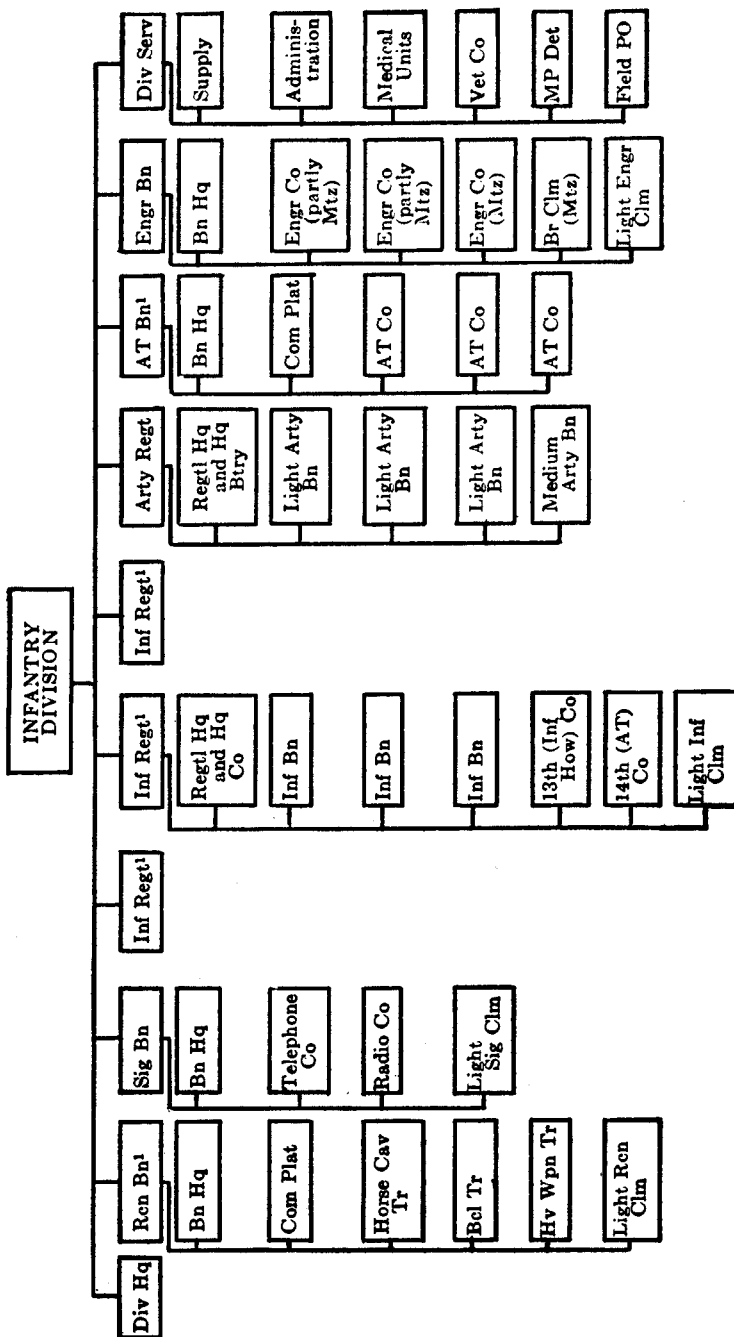

<sup>1</sup> See par. 30.

### b. Infantry Division (Infanteriedivision): Strength and Weapons

Unit	Personnel	LMGs	Hv MGs	7.92-mm AT rifles	75-mm AT guns	20-mm AA/AT guns	50-mm Morts	81-mm Morts	75-mm Inf Hows	150-mm Inf Hows	105-mm Hows	105-mm guns	150-mm Hows	Flame throwers	Arm'd cars
Div Hq	158	2													
Rein Bn	625	25	8		3	3	3	4	2						3
Sig Bn	474	17													
Inf Regt	3,250	123	36	27	12		27	18	6	2					
Inf Regt	3,250	123	36	27	12		27	18	6	2					
Inf Regt	3,250	123	36	27	12		27	18	6	2					
Arty Regt	2,500	32										36	4	8	
AT Bn	550	18			36										
Engr Bn	843	34		9										20	
Div Serv	2,300	30				8									
<b>TOTAL<sup>1</sup></b>	<b>17,200</b>	<b>527</b>	<b>116</b>	<b>90</b>	<b>75</b>	<b>11</b>	<b>84</b>	<b>58</b>	<b>20</b>	<b>6</b>	<b>36</b>	<b>4</b>	<b>8</b>	<b>20</b>	<b>3</b>

<sup>1</sup> A replacement battalion (*Feldersatzbattalion*), which varies greatly in strength and organization, may be added to any infantry division.

**c. Reconnaissance Battalion (Aufklärungsabteilung): Organization Chart (Inf Div)**

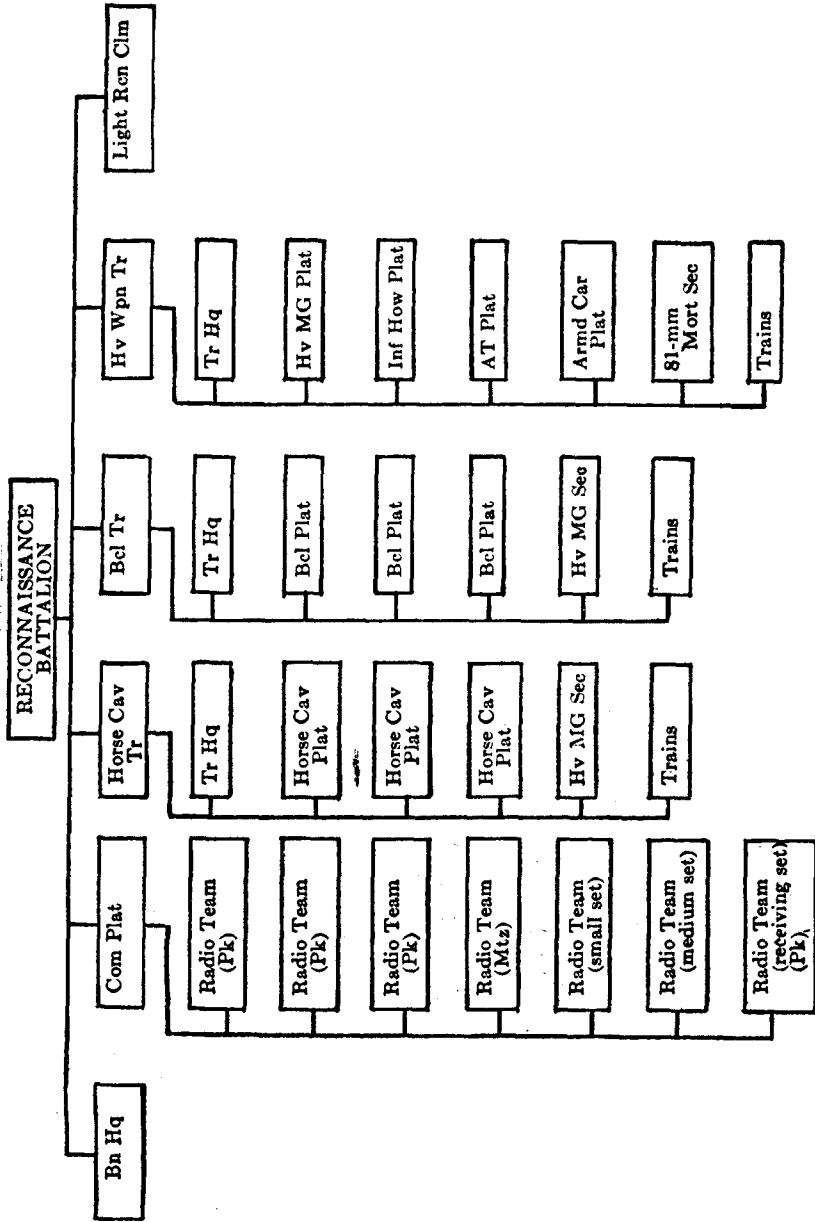

**d. Reconnaissance Battalion (Aufklärungsabteilung):  
Strength and Weapons (Inf Div)**

UNIT	Personnel	LMGs	Hv MCGs	75-mm AT guns	20-mm AA/AT guns	50-mm Morts	81-mm Morts	75-mm Inf Hows	Armd cars
Bn Hq	20								
Com Plat	35								
Horse Cav Tr <sup>1</sup>	205	9	2						
Bel Tr	180	9	2			3			
Hv Wpn Tr	150	5	4	3	3		4	2	3
Light Ren Clm	35	2							
<b>TOTAL</b>	<b>625</b>	<b>25</b>	<b>8</b>	<b>3</b>	<b>3</b>	<b>3</b>	<b>4</b>	<b>2</b>	<b>3</b>

<sup>1</sup> The horse cavalry troop is sometimes replaced by a bicycle troop.

e. Infantry Regiment (Grenadierregiment): Organization Chart (Inf Div)

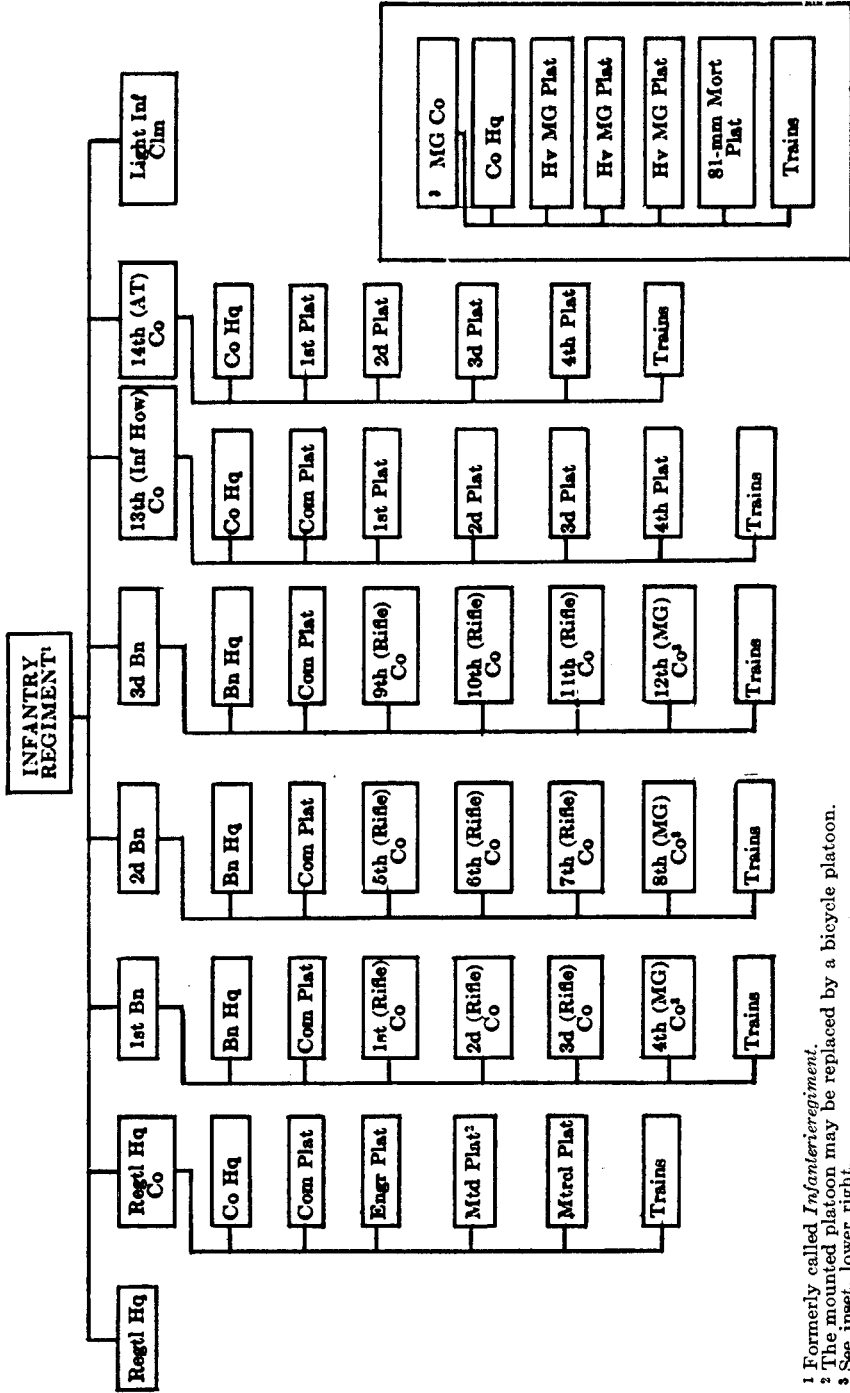

<sup>1</sup> Formerly called *Infanterieregiment*.

<sup>2</sup> The mounted platoon may be replaced by a bicycle platoon.

<sup>3</sup> See inset, lower right.

**f. Infantry Regiment (Grenadierregiment):  
Strength and Weapons (Inf Div)**

UNIT	Personnel	LMGs	Hv MGs	7.92-mm AT rifles	75-mm AT guns	50-mm Morts	81-mm Morts	75-mm Inf Hows	150-mm Inf Hows
Rifle Plat	50	4				1			
Rifle Co	190	12		3		3			
MG Co	200		12				6		
Inf Bn	850	36	12	9		9	6		
3 Inf Bns	2,550	108	36	27		27	18		
Regtl Hq	35								
Hq Co	215	3							
13th (Inf How) Co	190							6	2
14th (AT) Co	160	8			12				
Light Inf Clm	100	4							
<b>TOTAL</b>	<b>3,250</b>	<b>123</b>	<b>36</b>	<b>27</b>	<b>12</b>	<b>27</b>	<b>18</b>	<b>6</b>	<b>2</b>

g. Rifle Company (Grenadierkompanie): Organization Chart (Inf Div)

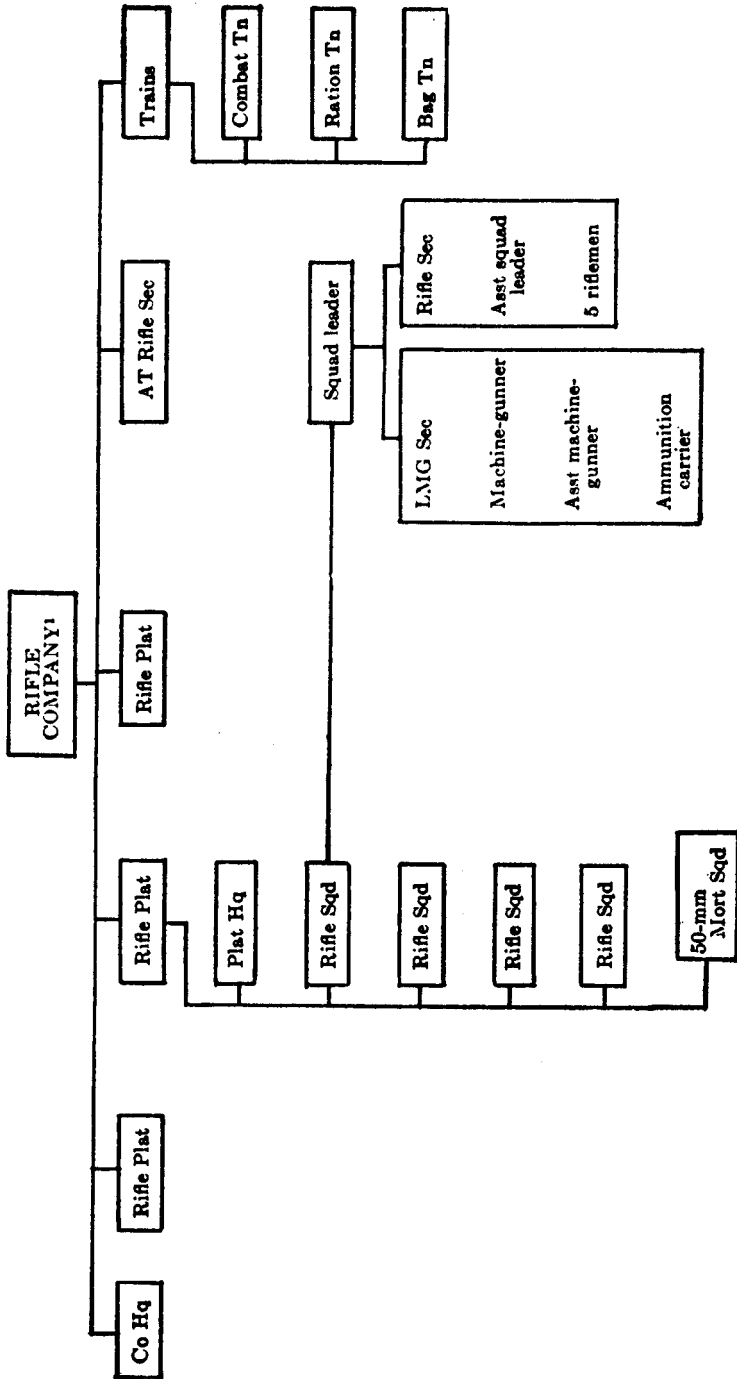

<sup>1</sup> Sometimes called *Schützenkompanie*.

**h. Artillery Regiment (Artillerieregiment): Organization Chart (Inf Div)**

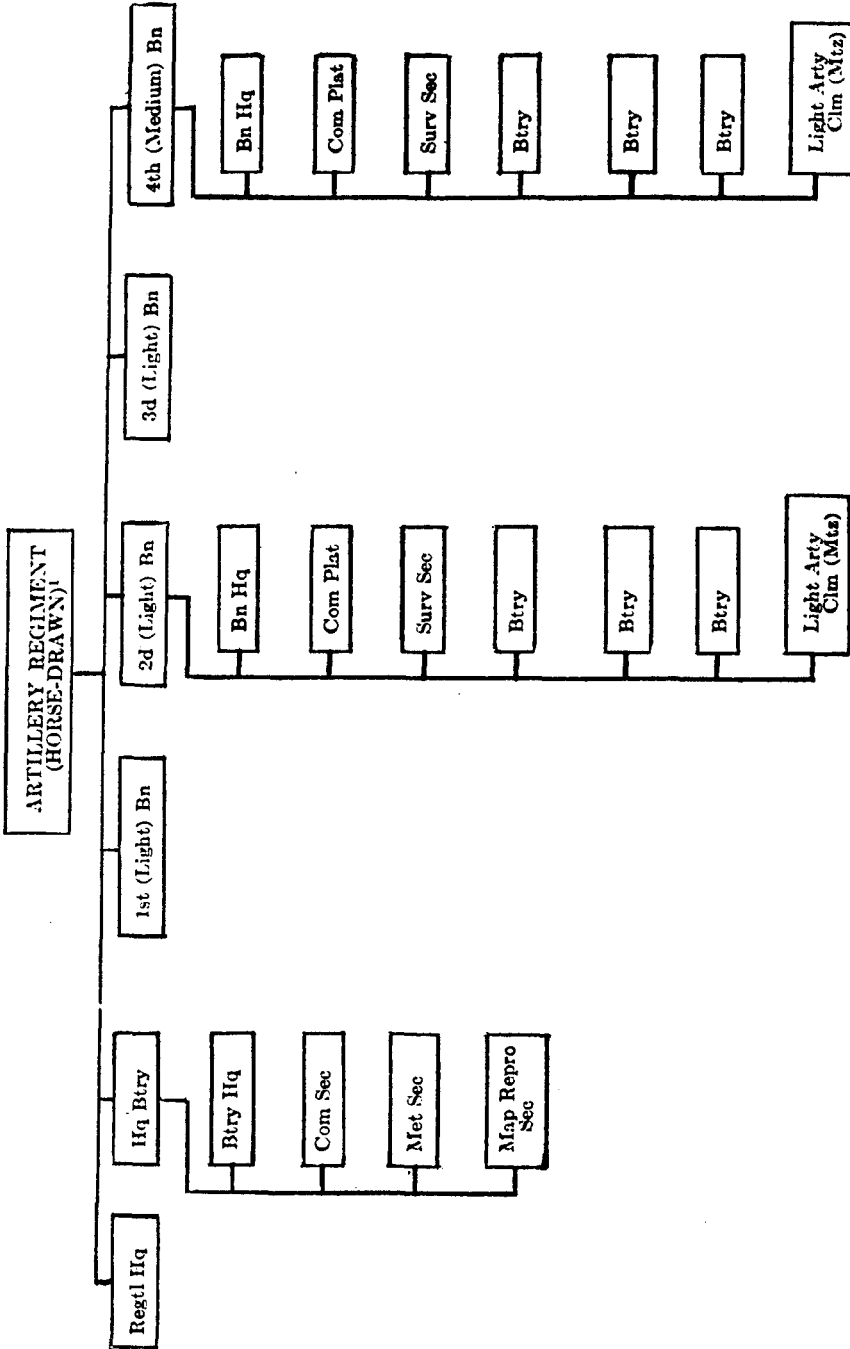

<sup>1</sup> May include a heavy chemical (smoke) battery with 150-mm six-barreled rocket projectors.



**i. Antitank Battalion (Panzerjägerabteilung): Organization Chart (Inf Div)**

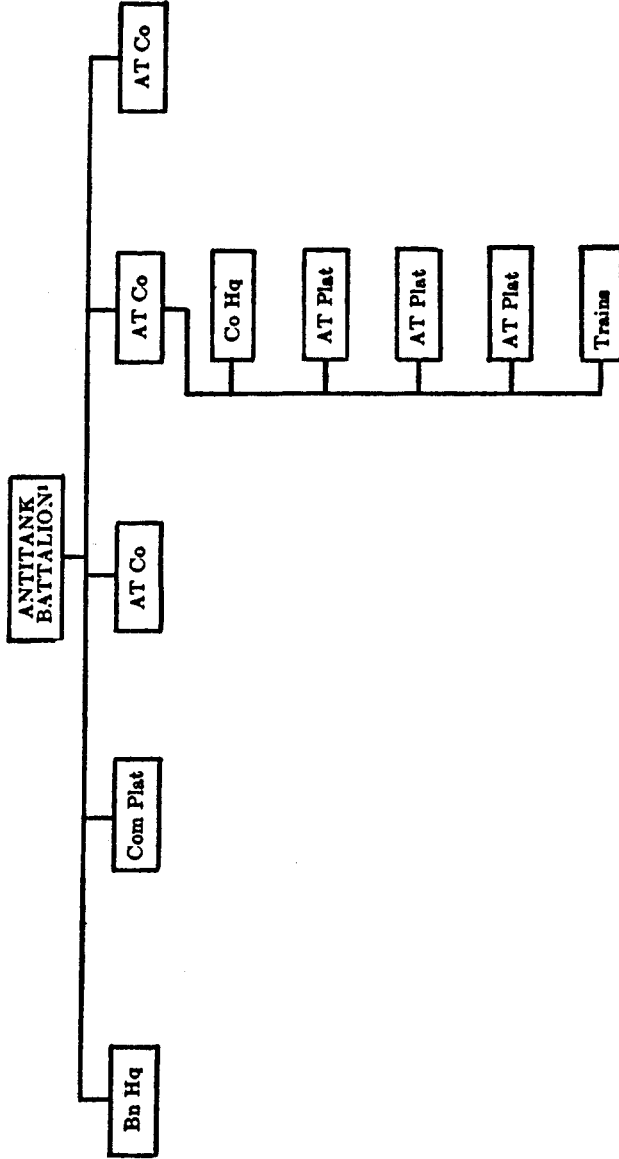

<sup>1</sup> In any antitank battalion, an anti-aircraft company may replace the third company or be added as a fourth company.

**j. Artillery Regiment (Artillerieregiment):  
Strength and Weapons (Inf Div)**

UNIT	Personnel	L.M.Gs	105-mm Hows	105-mm guns	150-mm Hows
Regtl Hq	35				
Hq Btry	115				
1st (Light) Bn	550	8	12		
2d (Light) Bn	550	8	12		
3d (Light) Bn	550	8	12		
4th (Medium) Bn <sup>1</sup>	700	8		4	8
<b>TOTAL</b>	<b>2,500</b>	<b>32</b>	<b>36</b>	<b>4</b>	<b>8</b>

<sup>1</sup> In the 4th (medium) battalion all 12 guns may be 155-mm howitzers.

**k. Antitank Battalion (Panzerjägerabteilung):  
Strength and Weapons (Inf Div)**

UNIT	Personnel	L.M.Gs	75-mm AT guns
Bn Hq	20		
Com Plat	35		
AT Co	165	6	12
AT Co	165	6	12
AT Co	165	6	12
<b>TOTAL</b>	<b>550</b>	<b>18</b>	<b>36</b>

## 32. ARMORED (PANZER) DIVISION: REORGANIZATION TREND

The German armored division is extremely flexible in composition and variable in equipment. The development of newer and heavier tanks and larger calibers of antitank guns and self-propelled mounts for all types of guns, even while older matériel remains in use, increases this variability. The charts in paragraph 33 therefore represent the basic type of the German armored division and its components, with the heaviest armament and equipment likely to be encountered. However, older matériel is still in use, new matériel may be encountered, and details of composition will vary. Consequently, because of the extreme variations that may occur, the actual composition and equipment of a particular armored division must be established by intelligence in the field and supplemented by intelligence previously obtained on that division.

The trend is constantly toward greater fire power, heavier armor, and increased motorization. The Germans apparently are equipping as many panzer-grenadier units as possible with armored troop carriers, but the proportion of units thus equipped will vary with every panzer division. There are indications that the *Pz.Kpfw. III* and even the *Pz.Kpfw. IV* may eventually be replaced by the *Panther* and even the *Tiger* tanks. If these replacements are made, a tank regiment may consist of two *Panther* tank battalions, one *Tiger* tank battalion, and one assault-gun battalion. Pending the re-equipment of the tank regiment, a transitional organization of it may be encountered. This organization may consist of two tank battalions of three or four companies each, or three tank battalions of three companies each. In either case, the organization will also include an assault battalion. The total number of tank companies in the tank regiment may therefore vary from six to nine. Any or all of the guns and howitzers of the antitank battalion and armored artillery regiment may be on self-propelled mounts.

**33. ARMORED (PANZER) DIVISION: TABLES OF ORGANIZATION**  
**a. Armored Division (Panzerdivision): Organization Chart**

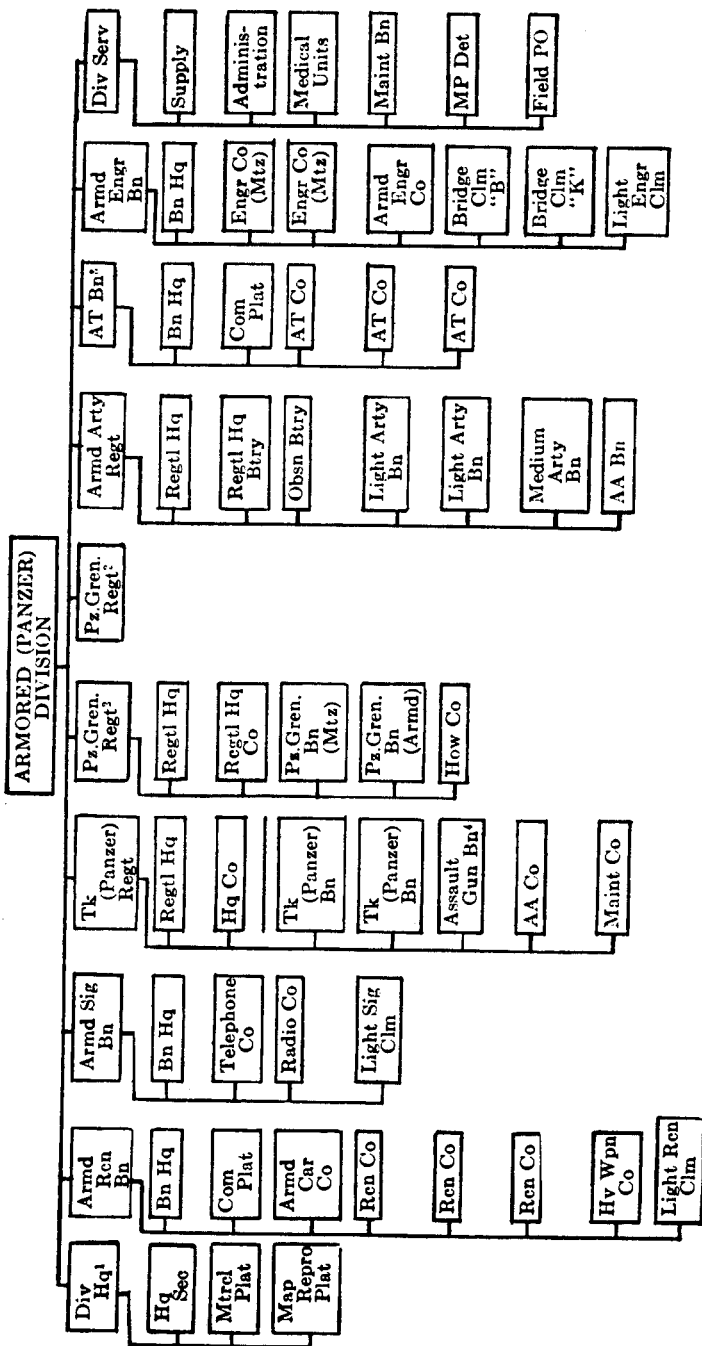

1 A division protection company (*Divisionsbegleitkompanie*) armed with AA and AT guns, infantry howitzers, and machine guns may be encountered in some divisions. Its primary purpose is the protection of division headquarters.  
 2 In the panzer division two typical panzer-grenadier regiments are indicated, each composed of one panzer-grenadier battalion (motorized) and one panzer-grenadier battalion (armored).  
 3 The organization and armament of the antitank battalion of the armored division is the same as that of the antitank battalion of the infantry division.  
 4 See par. 99a, p. 117.

**b. Armored Division (Panzerdivision): Strength and Weapons**

UNIT	Personnel	LMGs	Hv MGs	7.92-mm AT rifles	28/20-mm AT guns	37-mm AT guns	75-mm AT guns <sup>2</sup>	20-mm AA/AT guns	88-mm AA/AT guns	20-mm tank guns	50-mm or 75-mm tank guns <sup>3</sup>	75-mm tank guns (long) <sup>4</sup>	88-mm tank guns	81-mm Mortars	75-mm Inf Hows	150-mm Inf Hows	105-mm guns Hows	105-mm guns	150-mm Hows	Flame throwers	Arm'd vehicles	Pz.Kpfw. II tanks	Pz.Kpfw. III tanks	Pz.Kpfw. IV tanks	Pz.Kpfw. Panther tanks	Pz.Kpfw. Tiger tanks
Div Hq	182	2																								
Arm'd Recon Bn	1,140	89	12	9	3		3	12			6			6	2						24					
Arm'd Sig Bn	400	23																			27					
Tk (Panzer) Regt	3,000	291	16				31	12			52	56	28								6		52	28	28	28
Pz.Gren. Regt <sup>1</sup>	2,200	206	24	18	6	9	9							12	8	4					87					
Pz.Gren. Regt <sup>1</sup>	2,200	206	24	18	6	9	9							12	8	4					87					
Arm'd Arty Regt	2,800	54						18	8								24	4	8							
AT Bn	550	18					36																			
Arm'd Engr Bn	958	67			9					12										20	7	12				
Div Serv	2,200	35						8																		
<b>TOTAL</b>	<b>15,630</b>	<b>991</b>	<b>76</b>	<b>45</b>	<b>24</b>	<b>18</b>	<b>88</b>	<b>50</b>	<b>8</b>	<b>12</b>	<b>68</b>	<b>56</b>	<b>28</b>	<b>30</b>	<b>18</b>	<b>8</b>	<b>24</b>	<b>4</b>	<b>8</b>	<b>20</b>	<b>238</b>	<b>12</b>	<b>52</b>	<b>28</b>	<b>28</b>	<b>28</b>

<sup>1</sup> There is a tendency to equip the machine-gun platoon of the panzer-grenadier company (armored) with rocket projectors on self-propelled mounts.  
<sup>2</sup> Includes 31 assault guns in the tank regiment.  
<sup>3</sup> The 50-mm long-barreled tank gun or the 75-mm short-barreled tank gun is mounted in the Pz. Kpfw. III tank; the 75-mm short-barreled tank gun is also mounted in the eight-wheeled armored car, replacing the 20-mm gun.  
<sup>4</sup> Includes twenty-eight 75-mm long-barreled tank guns mounted in the Pz. Kpfw. IV tanks and twenty-eight 75-mm super-long-barreled tank guns mounted in the Panther tanks.

c. Armored Reconnaissance Battalion (Panzeraufklärungsabteilung):  
Organization Chart (Arm'd Div)

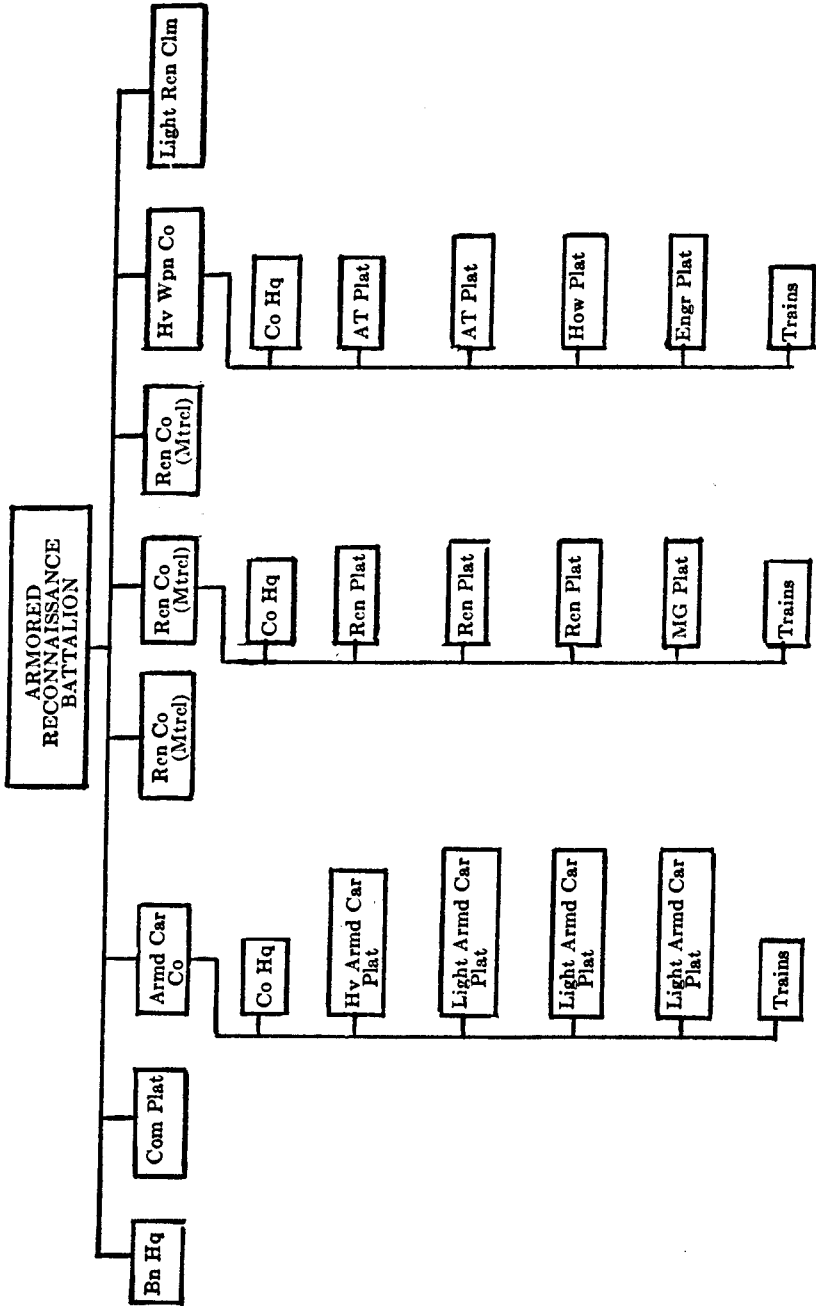

**d. Armored Reconnaissance Battalion (Panzeraufklarungs-  
abteilung): Strength and Weapons (Armd Div)**

UNIT	Personnel	LMGS	HvMGs	7.92-mm AT rifles	28/20-mm AT guns	75-mm AT guns	75-mm (short) tank guns	20-mm AA/AT guns	81-mm Morts	75-mm Inf Hows	Light Armd Cars	Hv Armd cars
Bn Hq	20											
Com Plat	60											
Armd Car Co	135	24					6	12			18	6
Ren Co (Mtrcl)	225	18	4	3					2			
Ren Co (Mtrcl)	225	18	4	3					2			
Ren Co (Mtrcl)	225	18	4	3					2			
Hv Wpn Co	150	7			3	3				2		
Light Ren Ctm	100	4										
<b>TOTAL</b>	<b>1,140</b>	<b>89</b>	<b>12</b>	<b>9</b>	<b>3</b>	<b>3</b>	<b>6</b>	<b>12</b>	<b>6</b>	<b>2</b>	<b>18</b>	<b>6</b>

**e. Tank Regiment (Panzerregiment): Organization Chart (Armd Div)**

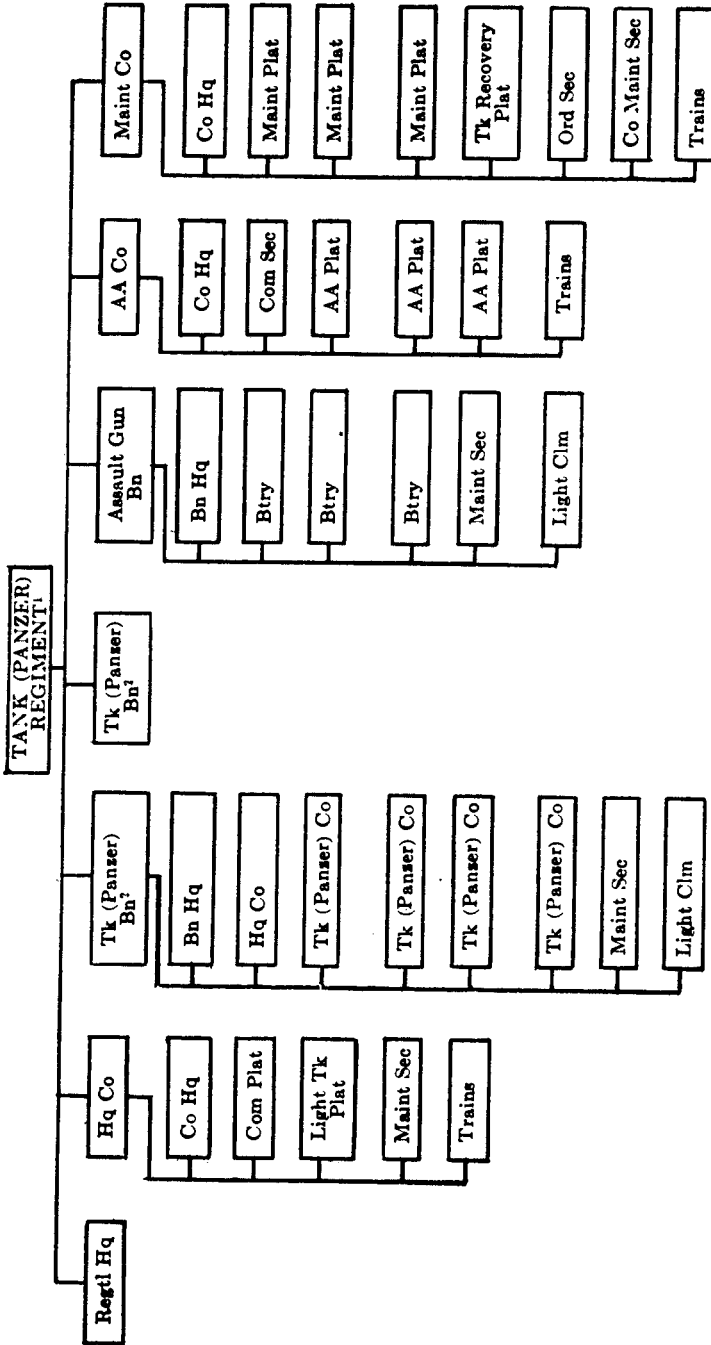

<sup>1</sup> Regiments of three battalions of three companies each may be encountered.  
<sup>2</sup> Probably no two tank battalions in the German Army are alike in organization and equipment. Any combination of tank companies of *Pz.* *Kp/w.* *III.* *IV.* *Panther.* and *Tiger* tanks is likely to be found within the battalion, with a trend toward predominance of companies of *Pz.* *Kp/w.* *IV.* *Panther.* and *Tiger* tanks.



**f. Tank Regiment (Panzerregiment):  
Strength and Weapons (Armd Div) <sup>1</sup>**

Unit	Personnel	LMGS	Hv MGS	75-mm AT guns self-propelled	20-mm AA/AT guns	50-mm or 75-mm tank guns <sup>2</sup>	75-mm tank guns (long) <sup>3</sup>	88-mm tank guns	Armd cars	Pz.Kpfw III tanks	Pz.Kpfw. IV tanks	Pz.Kpfw. Panther tanks	<sup>4</sup> Pz.Kpfw. Tiger tanks
Regtl Hq	35												
Hq Co	115	14				6			2	6			
Tk (Panzer) Bn <sup>4</sup>	950	127	8			23	28	14	2	23	14	14	14
Tk (Panzer) Bn <sup>4</sup>	950	127	8			23	28	14	2	23	14	14	14
Assault Gun Bn	550	11		31									
AA Co	180	4			12								
Maint Co	220	8											
<b>TOTAL</b>	<b>3,000</b>	<b>291</b>	<b>16</b>	<b>31</b>	<b>12</b>	<b>52</b>	<b>56</b>	<b>28</b>	<b>6</b>	<b>52</b>	<b>28</b>	<b>28</b>	<b>28</b>

<sup>1</sup> These figures are only roughly indicative of possible equipment and fire power. See **b**, above, notes 2, 3, and 4, and **e**, above, notes 1 and 2.

<sup>2</sup> The 50-mm long-barreled tank gun or the 75-mm short-barreled tank gun is mounted in the *Pz. Kpfw. III* tank.

<sup>3</sup> Includes twenty-eight 75-mm long-barreled tank guns mounted in the *Pz. Kpfw. IV* tanks and twenty-eight 75-mm super-long-barreled tank guns mounted in the *Panther* tanks.

<sup>4</sup> The trend is for companies of *Pz. Kpfw. IV*, *Panther*, and *Tiger* tanks to have 22 instead of 14 tanks, and for companies of *Pz. Kpfw. III* tanks to have 18 instead of 17 tanks.

**g. Tank Company (Panzerkompanie) (with Pz.Kpfw. III or IV tanks): Organization Chart (Armd Div)**

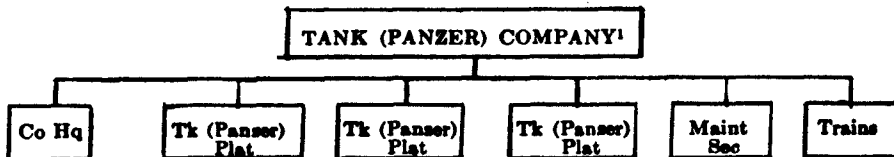

<sup>1</sup> The organization of the *Pz.Kpfw. Panther* tank company and *Pz.Kpfw. Tiger* tank company is similar, but sometimes includes 4 platoons with a total of 22 tanks.

**h. Tank Company (Panzerkompanie) (with Pz.Kpfw. III tanks): Strength and Weapons (Armd Div)**

Unit	Personnel	LMGs	50-mm or 75-mm tank guns <sup>1</sup>	Pz.Kpfw. III tanks
Co Hq	15	4	2	2
Tk (Panzer) Plat	35	10	5	5
Tk (Panzer) Plat	35	10	5	5
Tk (Panzer) Plat	35	10	5	5
Maint Sec	20			
Trains	10			
<b>TOTAL</b>	<b>150</b>	<b>34</b>	<b>17</b>	<b>17</b>

<sup>1</sup> Includes 50-mm long-barreled or 75-mm short-barreled tank guns mounted in the *Pz.Kpfw. III* tank.

**i. Tank Company (Panzerkompanie) (with Pz.Kpfw. IV, Panther, or Tiger tanks): Strength and Weapons (Armd Div)**

Unit	Personnel	LMGs	75-mm tank guns (long) <sup>1</sup>	Pz.Kpfw. IV tanks <sup>2</sup>
Co Hq	15	4	2	2
Tk (Panzer) Plat	35	8	4	4
Tk (Panzer) Plat	35	8	4	4
Tk (Panzer) Plat	35	8	4	4
Maint Sec	20			
Trains	10			
<b>TOTAL</b>	<b>150</b>	<b>28</b>	<b>14</b>	<b>14<sup>3</sup></b>

<sup>1</sup> 75-mm super-long-barreled tank guns in the case of *Pz. Kpfw. Panther* tank companies; 88-mm tank guns in the case of *Pz. Kpfw. Tiger* tank companies.

<sup>2</sup> *Pz. Kpfw. Panther* and *Pz. Kpfw. Tiger* tank companies substitute tanks of these designations.

<sup>3</sup> *Pz. Kpfw. Panther* and *Pz. Kpfw. Tiger* tank companies may have 4 platoons with a total of 22 tanks.

**i. Panzer-Grenadier Regiment (Panzergrenadierregiment):  
Organization Chart (Armd Div)**

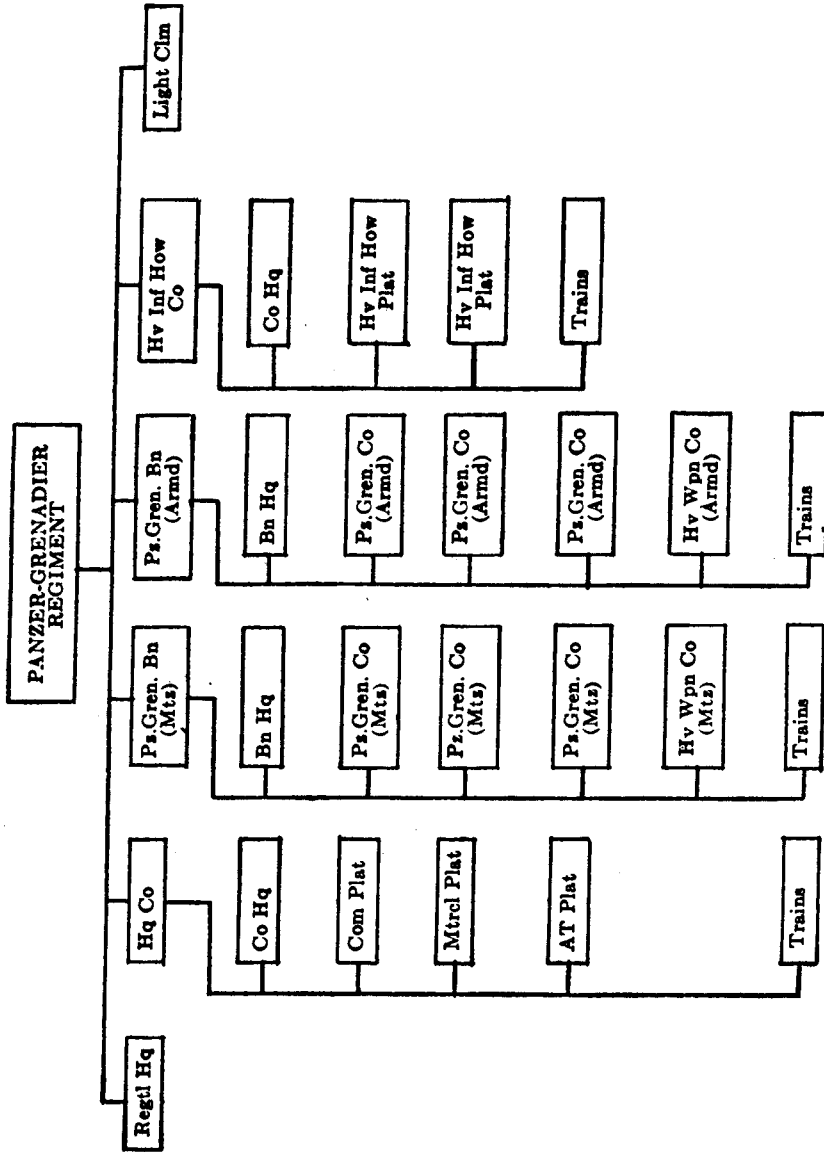

**k. Panzer-Grenadier Regiment (Panzergrenadierregiment):  
Strength and Weapons (Armd Div)**

Unit	Personnel	LMGs	Hv MGs	7.92-mm AT rifles	28/20-mm AT guns	37-mm AT guns	75-mm AT guns	81-mm Mortis	75-mm Inf Hows	150-mm Inf Hows	Armd half- track vehicles
Pz. Gren. Co (Mtz)	225	18	4	3	1			2			
Pz. Gren. Co (Armd) <sup>1</sup>	210	34	4	3		3		2			19
Hv Wpn Co (Mtz)	170	6			3		3		4		
Hv Wpn Co (Armd)	170	24					3		4		21
Bn Hq (Mtz) & Train	110										
Bn Hq (Armd) & Train	110	7									7
Regtl Hq	25	2									2
Hq Co	150	9					3				
Pz. Gren. Bn (Mtz)	955	60	12	9	6		3	6	4		
Pz. Gren. Bn (Armd)	910	133	12	9		9	3	6	4		85
Hv Inf How Co	110									4	
Light Clm	50	2									
<b>TOTAL</b>	<b>2,200</b>	<b>206</b>	<b>24</b>	<b>18</b>	<b>6</b>	<b>9</b>	<b>9</b>	<b>12</b>	<b>8</b>	<b>4</b>	<b>87</b>

<sup>1</sup>There is a tendency to equip the heavy platoon of the panzer-grenadier company (armored) with rocket projectors on self-propelled mounts.

### I. Panzer-Grenadier Company (Motorized) (*Panzergranadierkompanie*): Organization Chart (Armd Div)

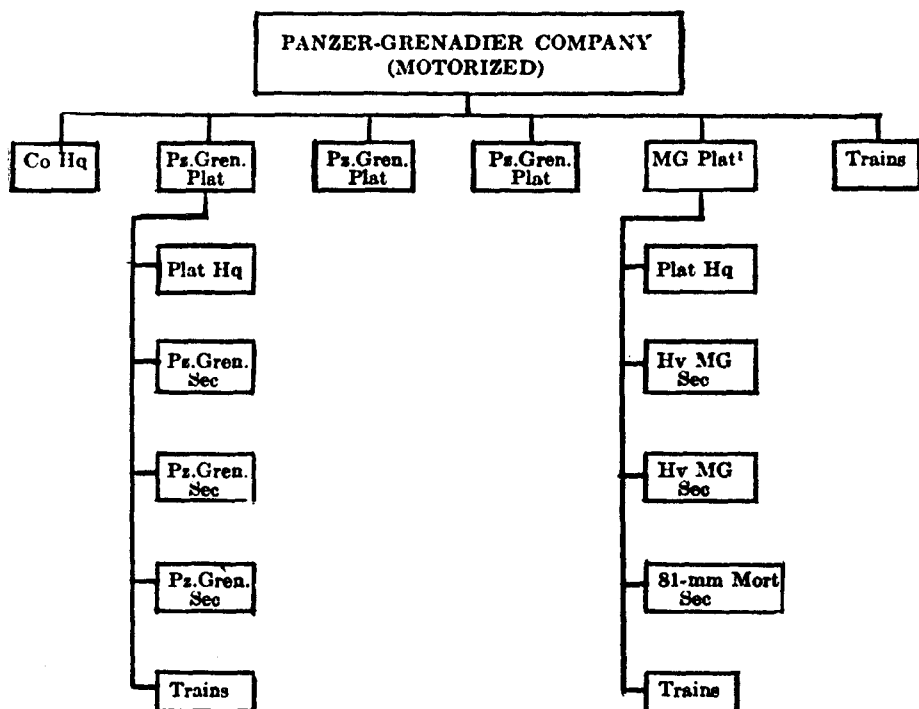

<sup>1</sup> There is some inconsistency in German nomenclature. Each fourth company of the infantry battalion is equipped with 12 heavy machine guns and six 81-mm mortars, and is called a machine-gun company (*Maschinengewehrkompanie*) (see par. 31e, p. 83). Each fourth platoon of the panzer-grenadier company (motorized and armored) is equipped with 4 heavy machine guns and two 81-mm mortars, but is called a heavy platoon (*schwerer Zug*) instead of a machine-gun platoon. For the purpose of consistency, however, it is here termed a machine-gun platoon.

**m. Panzer-Grenadier Company (Motorized) (Panzergranadierkompanie): Strength and Weapons (Armd Div)**

UNIT	Personnel	LMGs	Hv MGs	7.92-mm AT rifles	28/20-mm AT guns	81-mm Mortars
Co Hq	15				1	
Pz.Gren. Plat	45	6		1		
Pz.Gren. Plat	45	6		1		
Pz.Gren. Plat	45	6		1		
MG Plat	50		4			2
Trains	25					
<b>TOTAL</b>	<b>225</b>	<b>18</b>	<b>4</b>	<b>3</b>	<b>1</b>	<b>2</b>

**n. Panzer-Grenadier Platoon (Motorized) (Panzergranadierzug): Strength and Weapons (Armd Div)**

UNIT	Personnel	LMGs	7.92-mm AT rifles
Plat Hq	7		1
Pz.Gren. Sec	12	2	
Pz.Gren. Sec	12	2	
Pz.Gren. Sec	12	2	
Trains	2		
<b>TOTAL</b>	<b>45</b>	<b>6</b>	<b>1</b>

**o. Machine-gun Platoon (Motorized) (schwerer Zug): Strength and Weapons (Armd Div)**

UNIT	Personnel	Hv MGs	81-mm Mortars
Plat Hq	6		
Hv MG Sec	14	2	
Hv MG Sec	14	2	
81-mm Mort Sec	14		2
Trains	2		
<b>TOTAL</b>	<b>50</b>	<b>4</b>	<b>2</b>

**p. Panzer-Grenadier Company (Armored)**  
**(Panzergrenadierkompanie (gep)):**  
**Organization Chart (Armd Div)**

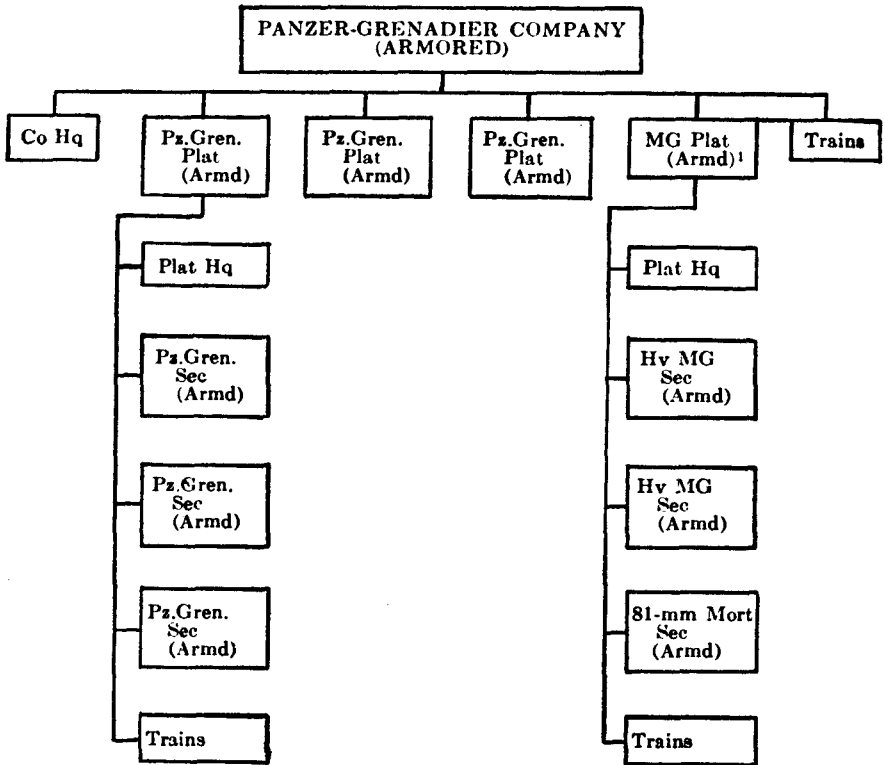

<sup>1</sup> See I, note 1, above.



**q. Panzer-Grenadier Company (Armored) (Panzergrenadierkompanie (gep)): Strength and Weapons (Armd Div)**

UNIT	Personnel	LMGs	Hv MGs	7.92-mm AT rifles	37-mm AT guns	81-mm Morts	Armd half-track vehicles
Co Hq	15	2					2
Pz.Gren. Plat (Armd)	40	9		1	1		4
Pz.Gren. Plat (Armd)	40	9		1	1		4
Pz.Gren. Plat (Armd)	40	9		1	1		4
MG Plat (Armd)	50	5	4			2	5
Trains	25						
<b>TOTAL</b>	<b>210</b>	<b>34</b>	<b>4</b>	<b>3</b>	<b>3</b>	<b>2</b>	<b>19</b>

**r. Panzer-Grenadier Platoon (Armored) (Panzergrenadierzug (gep)): Strength and Weapons (Armd Div)**

UNIT	Personnel	LMGs	7.92-mm AT rifles	37-mm AT guns	Armd half-track vehicles
Plat Hq	5		1	1	1
Pz.Gren. Sec (Armd)	11	3			1
Pz.Gren. Sec (Armd)	11	3			1
Pz.Gren. Sec (Armd)	11	3			1
Trains	2				
<b>TOTAL</b>	<b>40</b>	<b>9</b>	<b>1</b>	<b>1</b>	<b>4</b>

**s. Machine-gun Platoon (Armored) (schwerer Zug (gep) ):  
Strength and Weapons (Armd Div)**

UNIT	Personnel	LMGs	Hv MGs	81-mm Mortars	Armd half-track vehicles
Plat Hq	6	1			1
Hv MG Sec (Armd)	14	1	2		1
Hv MG Sec (Armd)	14	1	2		1
81-mm Mortar Sec (Armd)	14	2		2	2
Trains	2				
<b>TOTAL</b>	<b>50</b>	<b>5</b>	<b>4</b>	<b>2</b>	<b>5</b>

**t. Heavy-Weapons Company (schwere Kompanie):  
Organization Chart (Armd Div)**

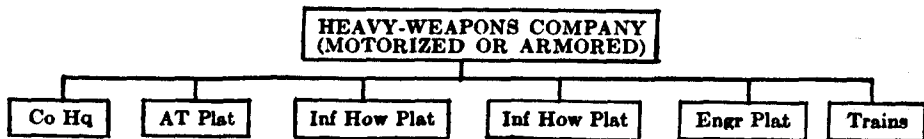

**u. Heavy-Weapons Company (Motorized) (schwere Kompanie): Strength and Weapons (Armd Div)**

UNIT	Personnel	LMGs	28/20-mm AT guns	75-mm AT guns	75-mm Inf Hows
Co Hq	15				
AT Plat	35	2	3	3	
Inf How Plat	25				2
Inf How Plat	25				2
Engr Plat	50	4			
Trains	20				
<b>TOTAL</b>	<b>170</b>	<b>6</b>	<b>3</b>	<b>3</b>	<b>4</b>

**v. Heavy-Weapons Company (Armored) (schwere Kompanie (gep)): Strength and Weapons (Armd Div)**

UNIT	Personnel	LMGs	75-mm AT guns	75-mm Inf Hows	Armd half-track vehicles
Co Hq	15	4			4
AT Plat	35	9	3		6
Inf How Plat	25	2		2	2
Inf How Plat	25	2		2	2
Engr Plat	50	5			5
Trains	20	2			
<b>TOTAL</b>	<b>170</b>	<b>24</b>	<b>3</b>	<b>4</b>	<b>21</b>

**w. Armored Artillery Regiment (Panzerartillerieregiment):  
Organization Chart (Armd Div)**

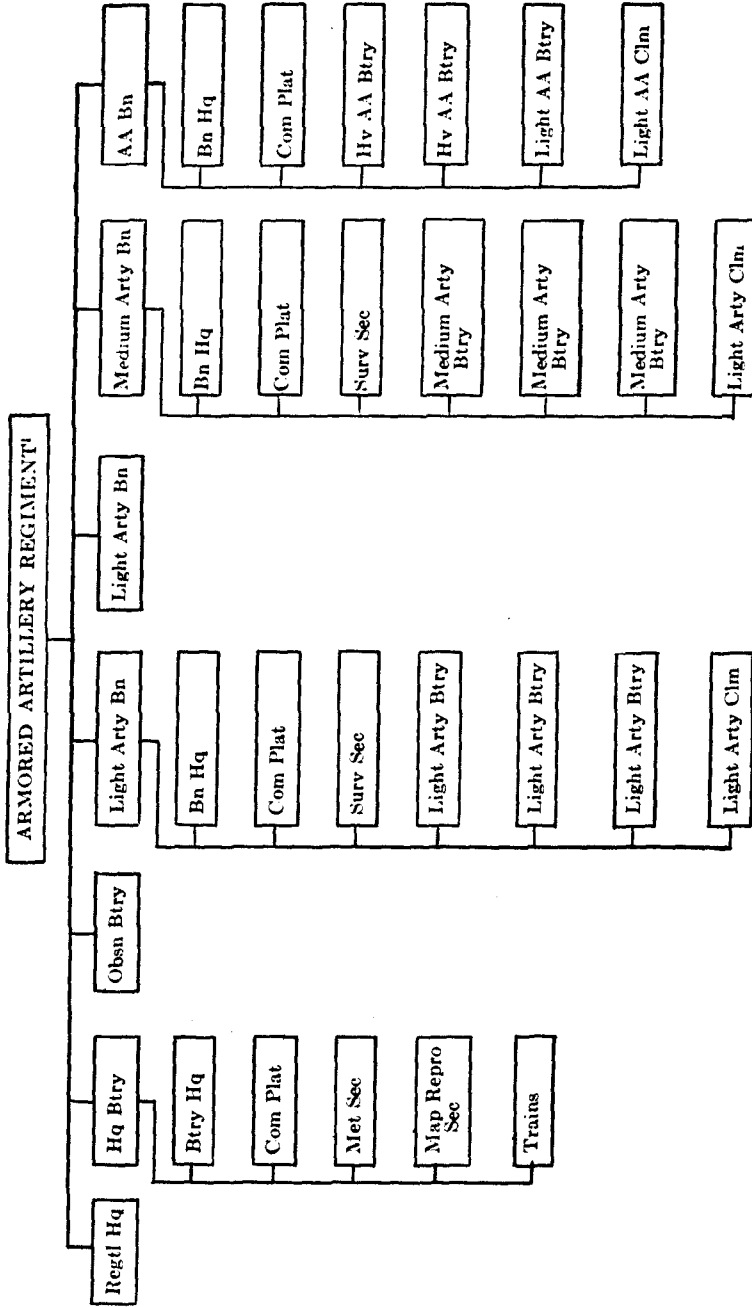

<sup>1</sup> May include a heavy chemical (smoke) battery equipped with 150-mm six-barreled rocket projectors.

**x. Armored Artillery Regiment (Panzerartillerieregiment):  
Strength and Weapons (Armd Div)**

UNIT	Personnel	LMGs	20-mm AA/AT guns	88-mm AA/AT guns	105-mm Hows	105-mm Guns	150-mm Hows
Regtl Hq	35						
Hq Btry	115	2					
Obsn Btry	250	24					
Light Arty Bn <sup>1</sup>	525	8			12		
Light Arty Bn <sup>1</sup>	525	8			12		
Medium Arty Bn <sup>1,2</sup>	650	8				4	8
AA Bn	700	4	18	8			
<b>TOTAL</b>	<b>2,800</b>	<b>54</b>	<b>18</b>	<b>8</b>	<b>24</b>	<b>4</b>	<b>8</b>

<sup>1</sup> May be self-propelled and consist of 18 instead of 12 pieces (6 instead of 4 pieces per battery).

<sup>2</sup> In the 3d (medium) battalion, all 12 guns may be 150-mm howitzers.

### 34. MOTORIZED DIVISION: TABLES OF ORGANIZATION

#### a. Motorized Division (Panzergranadierdivision): Organization Chart

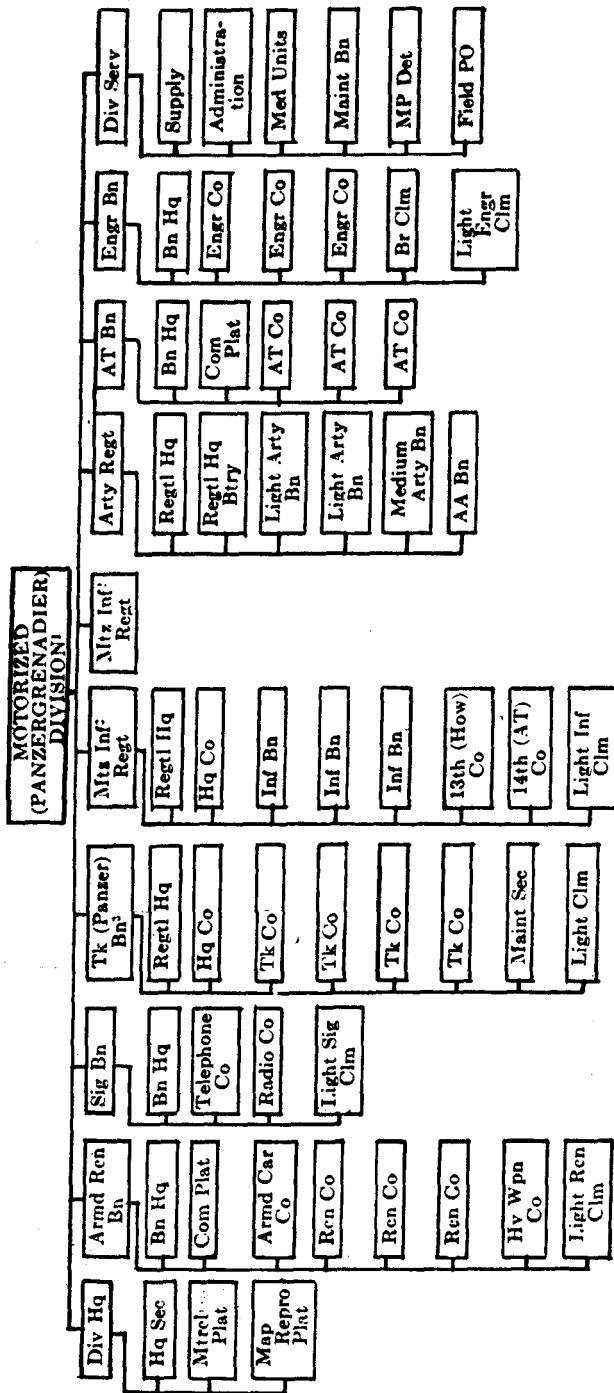

<sup>1</sup> The organization is the same as that of the infantry division (see par. 31a, p. 79), except for (a) the armored reconnaissance battalion, which is the same as the armored reconnaissance battalion in the armored division (see par. 33c, p. 92); (b) the engineer battalion; and (c) the substitution of one tank battalion for one infantry regiment.

<sup>2</sup> The panzer-granadier division usually has two motorized infantry regiments. The number of weapons and equipment is based on the similarity of the infantry battalions in the motorized division with the infantry battalions of the armored division, which would result in a larger number of machine guns and antitank guns (i.e., 18 light machine guns per company instead of 12, and with the heavy machine guns and 81-mm mortars distributed in machine-gun platoons of the rifle companies). If these reports are correct, the number of automatic small arms in the motorized infantry regiment would be approximately 50% greater than in the ordinary infantry regiment (see par. 31f, p. 84).

<sup>3</sup> Probably no two tank battalions in the German Army are alike in organization and equipment. Any combination of tank companies of Pz. K<sup>ampf</sup>. III, IV, Panther, and Tiger tanks is likely to be found within the battalion, with a trend toward predominance of companies of Pz. K<sup>ampf</sup>. IV, Panther, and Tiger tanks.

**b. Motorized Division (Panzergranadierdivision): Strength and Weapons**

UNIT	Personnel	LMGs	Hv MGs	7.92-mm AT rifles	28/20-mm AT guns	75-mm AT guns	20-mm AA/AT guns	88-mm AA/AT guns	50-mm or 75-mm tank guns <sup>1</sup>	75-mm tank guns (long) <sup>2</sup>	88-mm tank guns	50-mm mortars	81-mm mortars	75-mm Inf Hows	150-mm Inf Hows	105-mm Hows	105-mm Hows	150-mm Hows	Flame throwers	Armd vehicles	Pz. Kpfw. III tanks	Pz. Kpfw. IV tanks	Pz. Kpfw. (Panther) tanks	Pz. Kpfw. (Tiger) tanks	
Div Hq	181	2																		24					
Armd Recon Bn	1,140	89	12	9	3	3	12		6				6	2											
Sig Bn	456	17																			2				
Tk (Panzer) Bn	950	127	8						23	28	14											23	14	14	14
Mtz Inf Regt	3,250	123	36	27	12	12						27	18	6	2										
Mtz Inf Regt	3,250	123	36	27	12	12						27	18	6	2										
Arty Rec'tl	2,550	30					18	8								24	4	8							
AT Bn	550	18			36																				
Engr Bn	873	61			9														20						
Div Serv	1,900	30					8																		
<b>TOTAL</b>	<b>15,100</b>	<b>620</b>	<b>92</b>	<b>63</b>	<b>12</b>	<b>63</b>	<b>38</b>	<b>8</b>	<b>29</b>	<b>28</b>	<b>14</b>	<b>54</b>	<b>42</b>	<b>14</b>	<b>4</b>	<b>4</b>	<b>24</b>	<b>4</b>	<b>8</b>	<b>20</b>	<b>26</b>	<b>23</b>	<b>14</b>	<b>14</b>	<b>14</b>

<sup>1</sup> The artillery battalions may be self-propelled and consist of 18 instead of 12 pieces (6 instead of 4 pieces per battery). In the 3d (medium) battalion all 12 guns may be 150-mm howitzers.

<sup>2</sup> The 50-mm long-barreled or 75-mm short-barreled tank gun is mounted in the Pz. Kpfw. III tank.

<sup>3</sup> Includes 75-mm tank guns mounted in the Pz. Kpfw. IV tank and 75-mm super-long-barreled tank guns mounted in the Pz. Kpfw. Panther tank.

**35. LIGHT DIVISION: TABLES OF ORGANIZATION**  
**a. Light Division (Jägerdivision): Organization Chart**

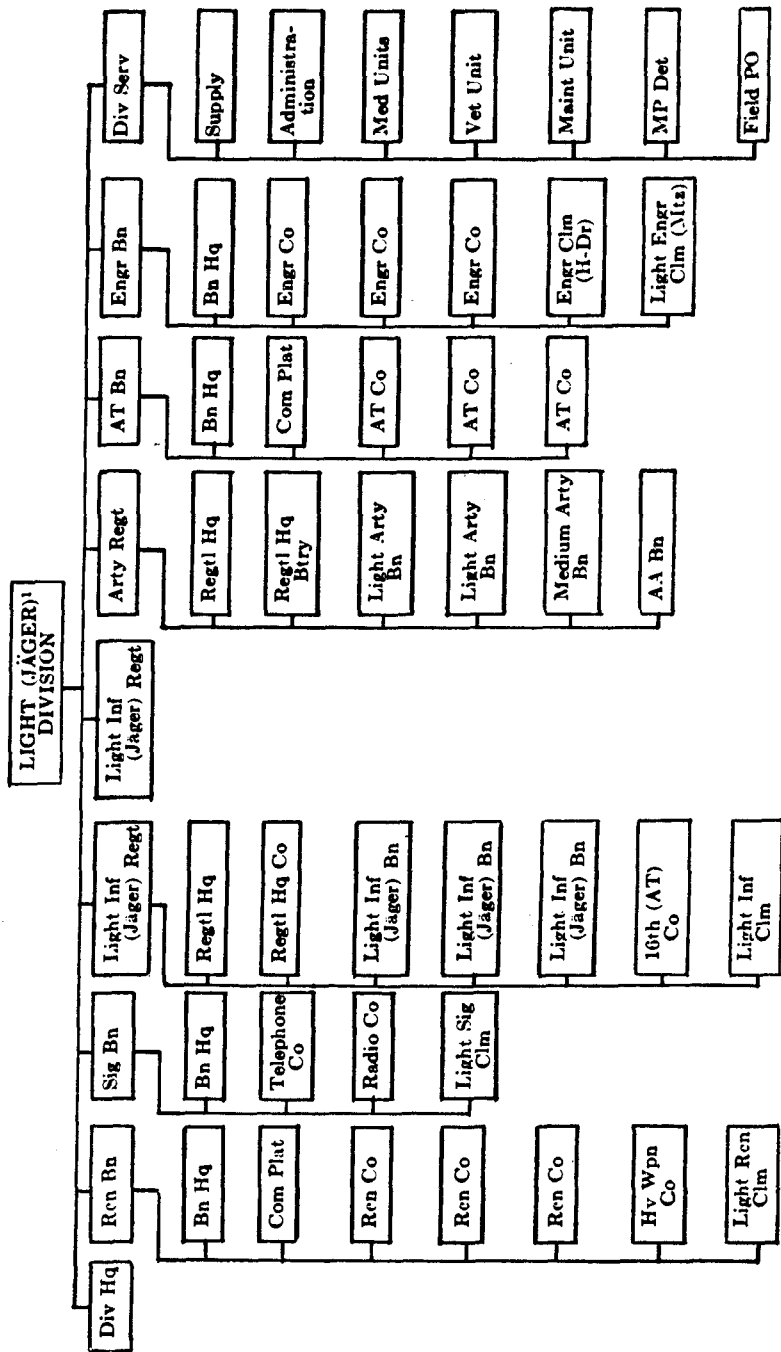

1 The light division is reported to be organized in general along the lines of the mountain division (see par. 36a, p. 112); however, it is believed to contain in addition heavy artillery and partly motorized transportation similar to that of the motorized division (see par. 34b, p. 109). The organization and equipment of the light division seem to vary according to the terrain in which it operates.



**b. Light Division (Jägerdivision): Strength and Weapons**

UNIT	Personnel	LMGs	Hv MGs	7.92-mm AT rifles	28/20-mm AT guns	50-mm AT guns	75-mm AT guns	20-mm AA/ AT guns	88-mm AA/ AT guns	50-mm Mortars	81-mm Mortars	120-mm Mortars	105-mm Hows	105-mm guns	150-mm Hows	76-mm Mtn Hows	Flame throwers
Div Hq	175	2															
Ren Bn	825	31	10		4					9	6	4				2	
Sig Bn	400	17															
Light Inf (Jäger) Regt	3,650	138	36	27	12	12				27	18	12				6	
Light Inf (Jäger) Regt	3,650	138	36	27	12	12				27	18	12				6	
Arty Regt	2,550	30							18	8			24	4	8		
AT Bn	550	18					36										
Engr Bn	820	31			9												20
Div Serv	1,900	30						8									
<b>TOTAL</b>	<b>14,520</b>	<b>435</b>	<b>82</b>	<b>54</b>	<b>37</b>	<b>24</b>	<b>36</b>	<b>26</b>	<b>8</b>	<b>63</b>	<b>42</b>	<b>28</b>	<b>24</b>	<b>4</b>	<b>8</b>	<b>14</b>	<b>20</b>

36. MOUNTAIN DIVISION: TABLES OF ORGANIZATION  
 a. Mountain Division (Gebirgsdivision): Organization Chart

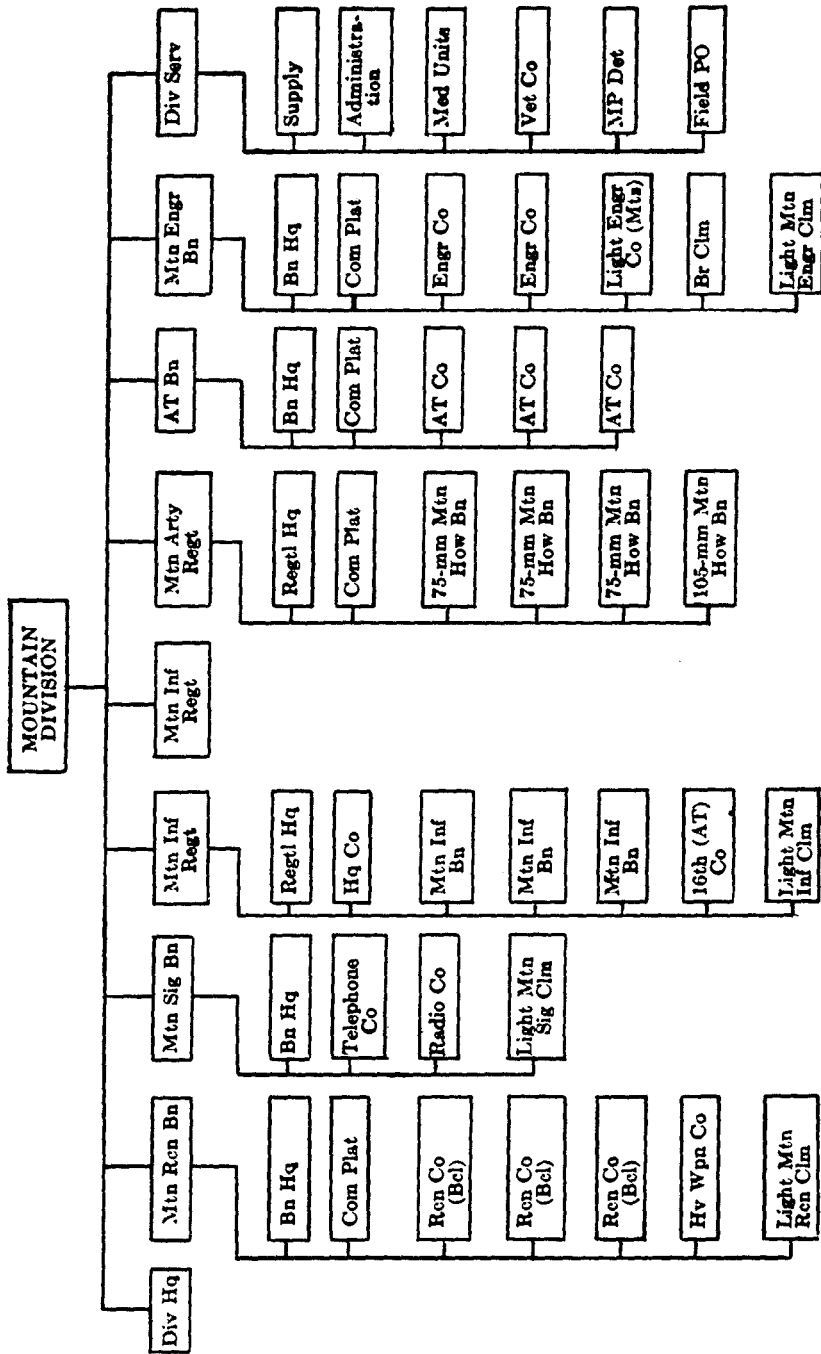

**b. Mountain Division (Gebirgsdivision): Strength and Weapons**

UNIT <sup>1</sup>	Personnel	LMGs	HV MGs	7.92-mm AT rifles	28/20-mm AT guns	50-mm AT guns	20-mm AA/ AT guns	50-mm mortars	81-mm mortars	120-mm mortars	75-mm Mtn Hows	105-mm Mtn Hows	Flame throwers
Div Hq	175	2											
Mtn Ren Bn <sup>2</sup>	825	31	10		4			9	0	4	2		
Mtn Sig Bn	400	17											
Mtn Inf Regt <sup>3</sup>	3,650	138	36	27	12	12		27	18	12	6		
Mtn Inf Regt <sup>3</sup>	3,650	138	30	27	12	12		27	18	12	6		
Mtn Arty Regt <sup>3</sup>	2,750	24									36	12	
AT Bn <sup>4</sup>	550	18				36							
Mtn Engr Bn	1,050	34			9								20
Div Serv	2,750	30					8						
<b>TOTAL</b>	<b>15,800</b>	<b>432</b>	<b>82</b>	<b>54</b>	<b>37</b>	<b>60</b>	<b>8</b>	<b>63</b>	<b>42</b>	<b>28</b>	<b>50</b>	<b>12</b>	<b>20</b>

<sup>1</sup> A replacement battalion (*Feldersatzbattalion*), which varies greatly in strength and organization, may be added to any mountain division.

<sup>2</sup> The guns in the mountain reconnaissance battalion and in the two mountain infantry regiments are usually mountain infantry howitzers having a maximum range of about 4,000 yards as compared with the maximum range of about 10,000 yards of the mountain artillery howitzers.

<sup>3</sup> Depending on the terrain, field artillery battalions may replace mountain artillery battalions.

<sup>4</sup> Although 50-mm antitank guns are listed, some units have received the new 75-mm antitank gun.

### 37. GHQ 120-MM MORTAR BATTALION: TABLES OF ORGANIZATION

#### a. 120-mm Mortar Battalion (*schwere Granatwerferabteilung*): Organization Chart

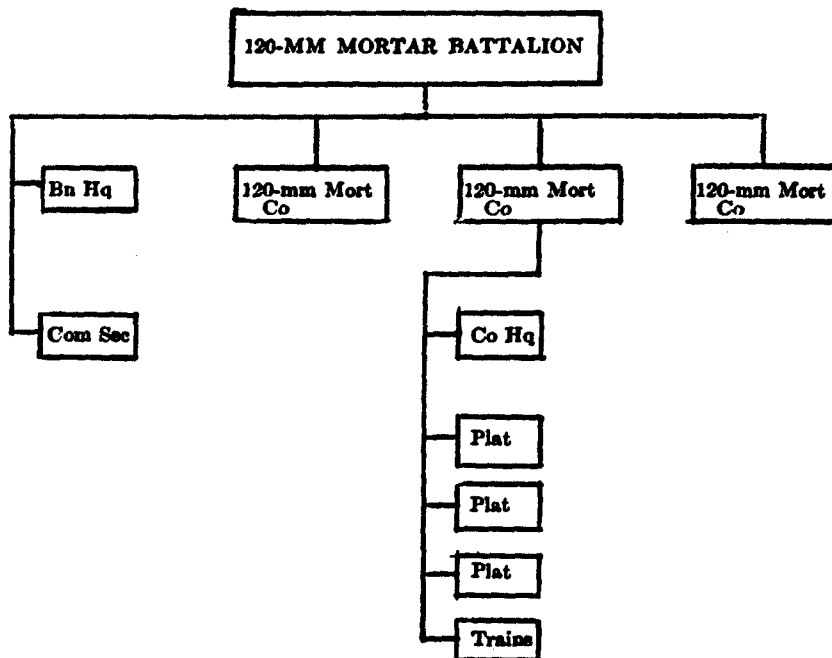

#### b. 120-mm Mortar Battalion (*schwere Granatwerferabteilung*): Strength and Weapons

Unit	Personnel	LMGs	120-mm Mortars
Bn Hq	20		
Com Sec	30		
120-mm Mort Co	180	3	12
120-mm Mort Co	180	3	12
120-mm Mort Co	180	3	12
Trains	35		
<b>TOTAL</b>	<b>625</b>	<b>9</b>	<b>36</b>

**38. GHQ HEAVY TANK BATTALION: TABLES OF ORGANIZATION**  
**a. Heavy Tank Battalion (schwere Panzerabteilung): Organization Chart**

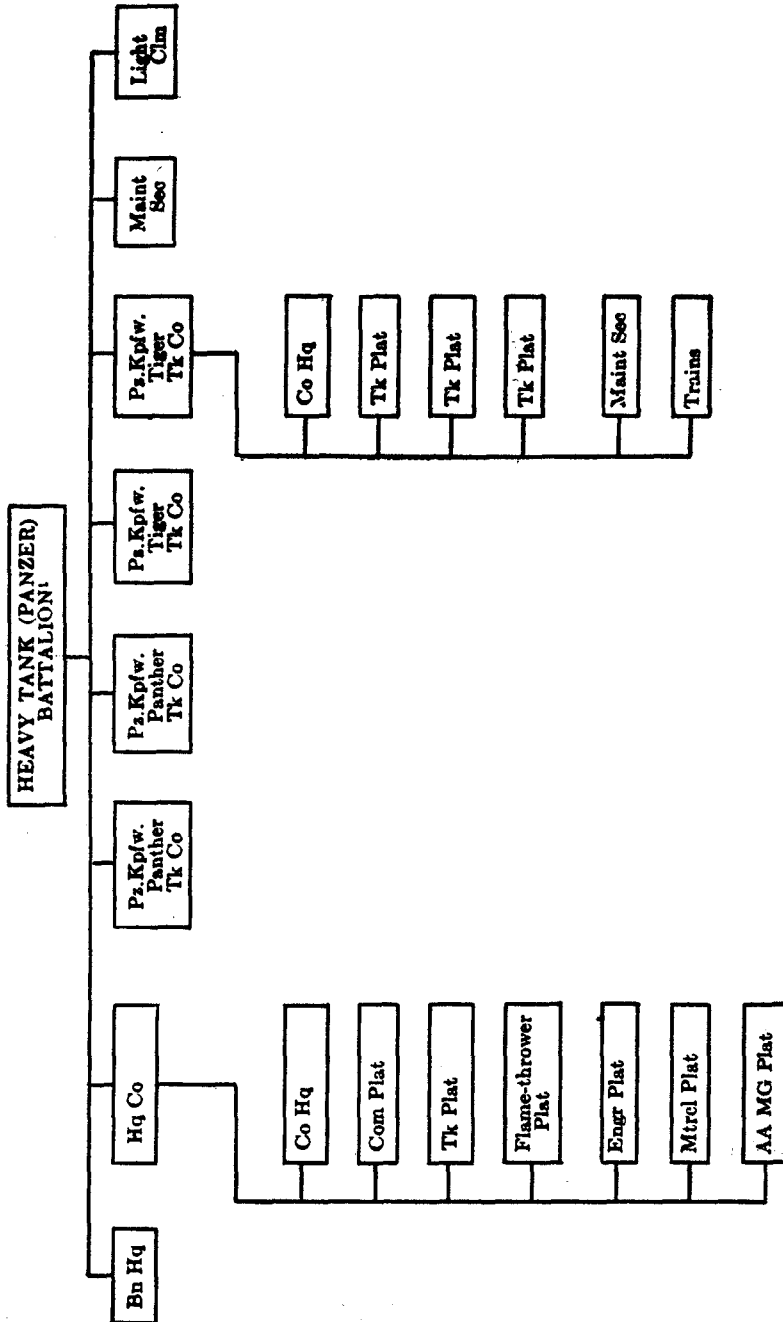

Battalions of two or three tank companies with correspondingly fewer men and less armament may also be encountered.

**b. Heavy Tank Battalion (schwere Panzerabteilung):  
Strength and Weapons**

UNIT	Personnel	LMGs	Hv MGs	75-mm Tk guns (long)	88-mm Tk guns	Pz.Kpfw. III tanks (flame-throwing)	Pz.Kpfw. IV tanks	Pz.Kpfw. Panther tank	Pz.Kpfw. Tiger tanks	Armd cars
Bn Hq	25									
Hq Co	260	31	8	6		5	6			2
Pz.Kpfw. Panther Tk Co	170	22		22				22		
Pz.Kpfw. Panther Tk Co	170	22		22				22		
Pz.Kpfw. Tiger Tk Co	170	44			22				22	
Pz.Kpfw. Tiger Tk Co	170	44			22				22	
Maint Co	200	8								
Light Cln	85	2								
<b>TOTAL</b>	<b>1,250</b>	<b>173</b>	<b>8</b>	<b>50</b>	<b>44</b>	<b>5</b>	<b>6</b>	<b>44</b>	<b>44</b>	<b>2</b>

**39. GHQ ANTITANK BATTALION: TABLES OF ORGANIZATION**  
**a. Antitank Battalion (Panzerjägerabteilung Tiger-P): Organization Chart**

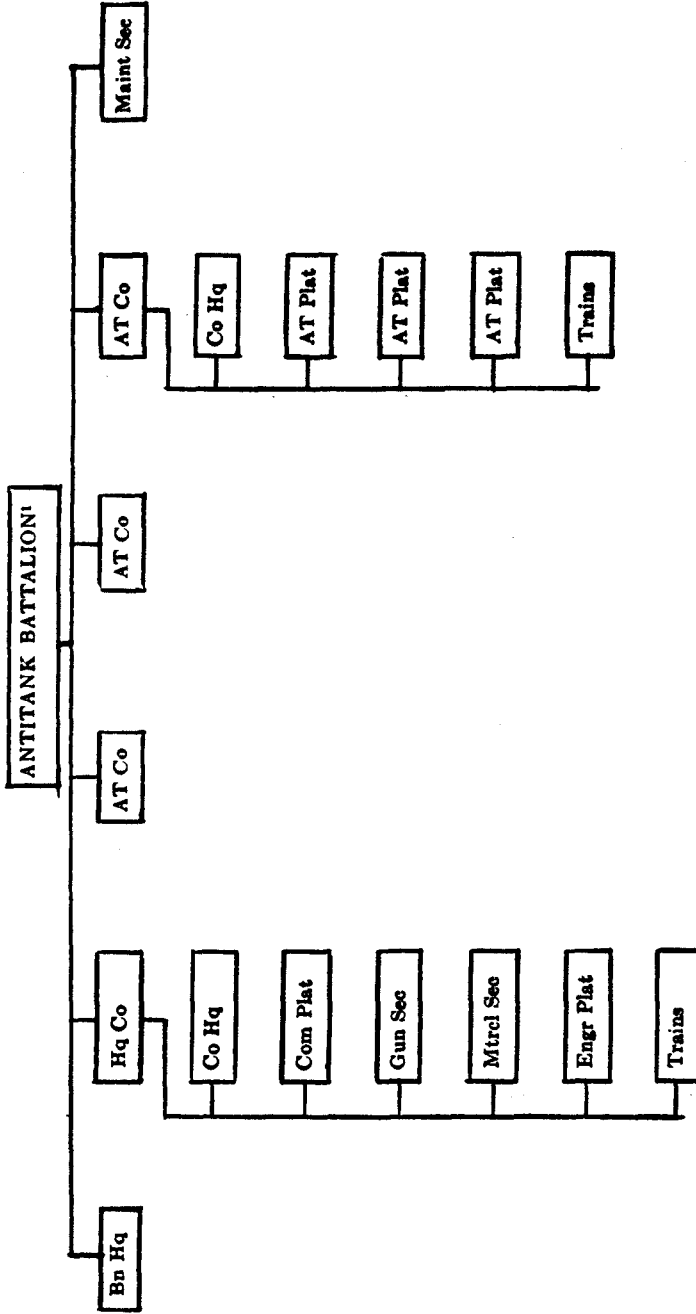

<sup>1</sup>The *Tiger-P* (*Porsche*) self-propelled antitank gun, which is also known as the *Ferdinand*, consists of the 88-mm self-propelled antitank gun (8.8 cm Stu. K. 43/1) mounted on the *Tiger* chassis (see fig. 57, p. 99). The *Panzerjägerabteilung Tiger-P* may now be replacing the assault-gun battalion (*Sturmgeschützabteilung*) in the armored division (par. 33a, p. 90)

**b. Antitank Battalion (*Panzerjägerabteilung Tiger-P*):  
Strength and Weapons**

UNIT	Personnel	LMGs	88-mm AT guns on SP mount	Pz. Kpfw. III tanks
Bn Hq	20			
Hq Co	110	4	3	1
AT Co	150	14	14	
AT Co	150	14	14	
AT Co	150	14	14	
Maint Sec	20			
<b>TOTAL</b>	<b>600</b>	<b>46</b>	<b>45</b>	<b>1</b>



**40. GHQ CHEMICAL (SMOKE) REGIMENTS: ORGANIZATION CHARTS**

**a. Chemical (Smoke) Regiment ((Nebel)Werferregiment) (with 105-mm Smoke Mortars or 150-mm Rocket Projectors)**

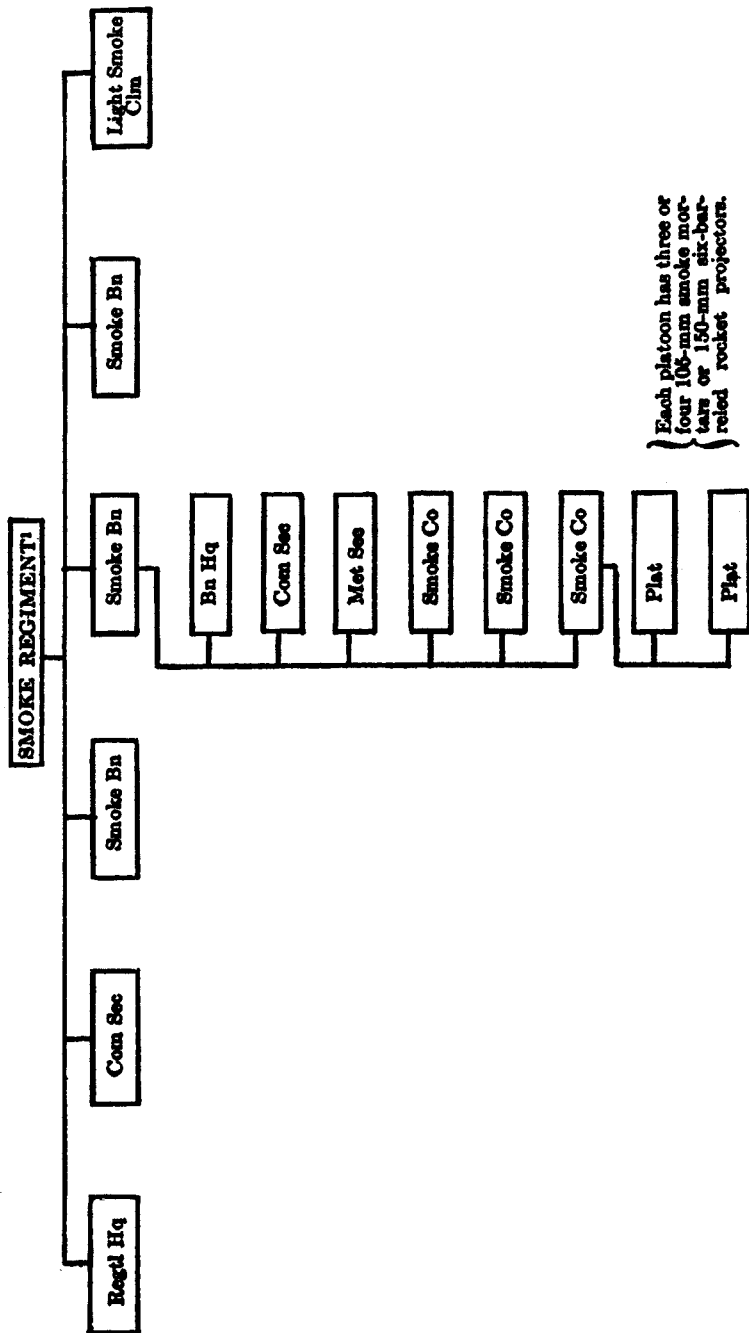

<sup>1</sup> The strength of the smoke regiment is about 1,800 officers and enlisted men. It is equipped with fifty-four 105-mm smoke mortars or 150-mm six-barreled rocket projectors.

**b. Heavy Chemical (Smoke) Regiment (schweres (Nebel) Werferregiment) (with 150-mm Rocket Projectors)**

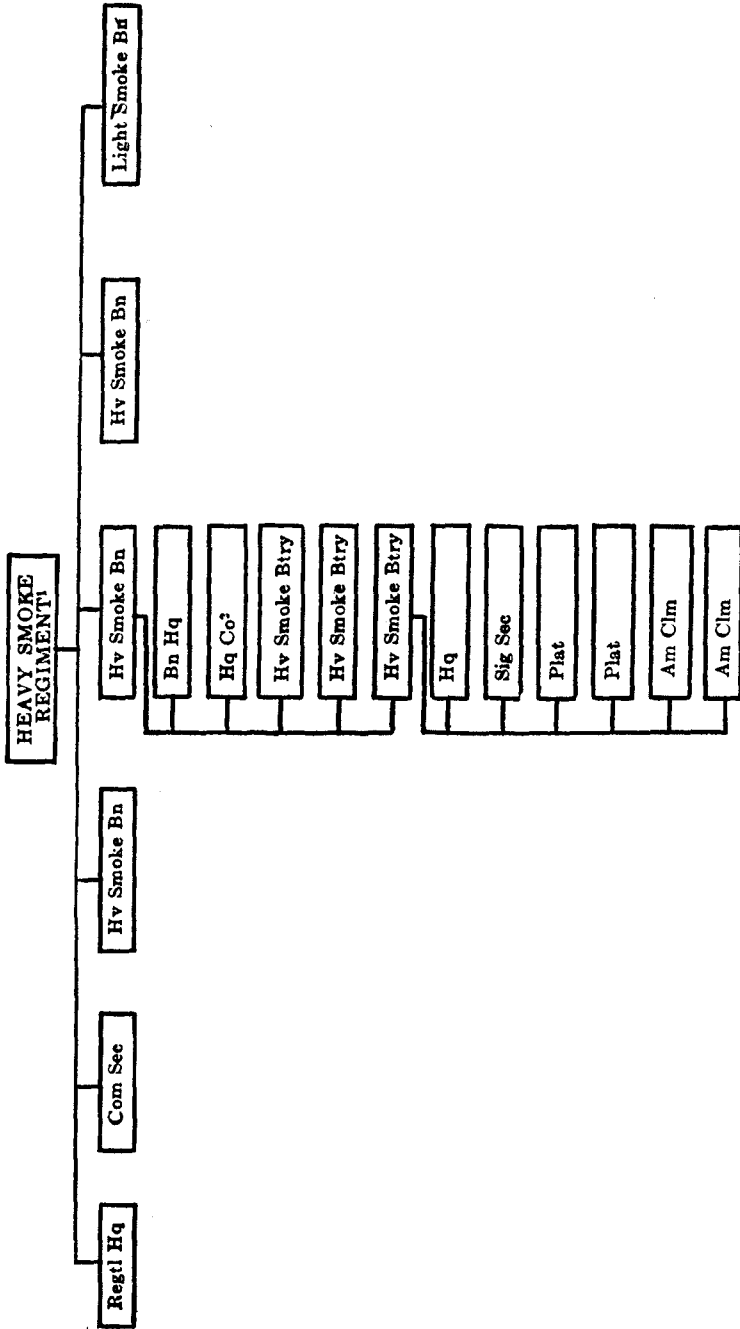

1. The strength of the heavy smoke regiment is about 1,705 officers and enlisted men. It is equipped with fifty-four to seventy-two 150-mm six-barreled rocket projectors.  
 2. Battalion headquarters company consists of a communication section and a meteorological section.

# Section VII. MILITARY SYMBOLS

---

## 41. GENERAL

The German Armed Forces use military symbols extensively on maps, in tables of organization, and on direction and location signposts in combat zones. Military symbols will also be seen on vehicles and equipment, with or without the divisional emblem. The German system of military symbols consists of a number of basic and supplementary symbols, which are used in combinations to indicate various headquarters, units, and equipment.

At the beginning of the present war, the Germans used an elaborate system of military symbols. Apparently the system was found to be too complicated for use in the field, and two lists of amendments (one dated November 1942 and the other January 1943) were issued with the object of simplifying the basic and supplementary symbols for weapons and equipment.

The revised system of military symbols is analyzed briefly below.<sup>1</sup> Inasmuch as many German charts, maps, and other documents may still employ the old basic symbols, the superseded symbols for weapons and equipment are also presented.

## 42. BASIC SYMBOLS FOR HEADQUARTERS

The following basic symbols are employed to indicate headquarters:

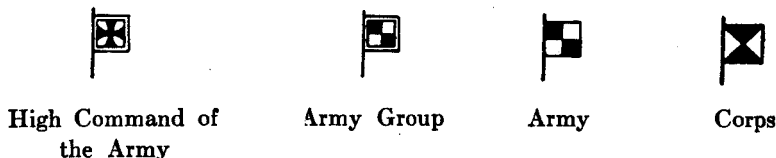

<sup>1</sup> For a more detailed analysis, see *German Military Symbols* (1 April 1944), published jointly by the Military Intelligence Division, War Department, Washington, and the Directorate of Military Intelligence, War Office, London.

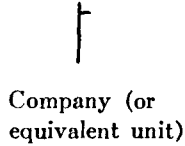

**43. BASIC SYMBOLS FOR BRANCHES OF SERVICE**

The following basic symbols are employed to indicate branches of service:

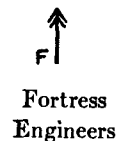
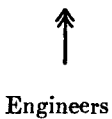
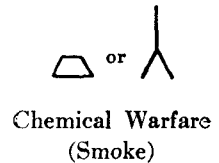
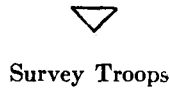
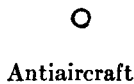
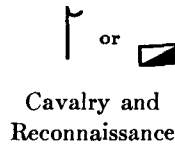
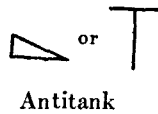

  
Construction  
Engineers

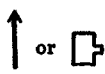
  
Signal  
Troops

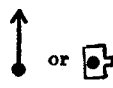
  
Railway  
Signal  
Troops

  
Supply  
Services

  
Transport Troops

  
Medical  
Services

  
Veterinary  
Services

  
Traffic Control  
Services

  
Military Police

  
Army Postal Services

Examples of tactical symbols composed by combining these basic symbols are as follows:

  
Hq Arty Regt

  
Hq Mtn Div

  
Hq AT Bn

#### 44. BASIC SYMBOLS FOR WEAPONS AND EQUIPMENT

The following basic symbols are employed to indicate weapons and equipment:

  
Machine Gun

  
Mortar

  
Infantry Howitzer

  
Flame Thrower



Antitank Rifle



Antitank Gun

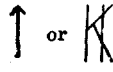

Gun

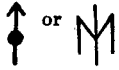

Howitzer

High-angle  
Howitzer (Mörser)(Smoke)  
ProjectorSmoke  
EquipmentAntiaircraft  
Gun

Tank



Assault Gun



Searchlight



Balloon Barrage

Half-track  
Personnel  
Carrier"Volkswagen"  
(Jeep)

Scout Car

Armored Command  
Vehicle

## 45. INDICATION OF UNITS

Companies and equivalent units are indicated in the following manner:

(a) By thickening the left side of the basic symbol for the branch of service. *Examples:*



Rifle Co



Tk Co



AT Co



Sig Co

(b) By combining a square with thickened side with the basic symbol for the branch of service. *Examples:*



Mtn Rifle Co



Engr Co



Sup Co

(c) By thickening part of the basic symbol for weapon or equipment. *Examples:*



Artillery batteries are indicated by the weapon symbol with a numeral below it indicating the number of weapons in the battery.

Platoons and equivalent units are indicated by the company symbol, as in (a) and (b), above, but without the thickened side. *Examples:*



#### 46. SUPPLEMENTARY SYMBOLS

Methods of transportation are indicated by the following supplementary symbols:



Fully Motorized



Partly Motorized



Towed  
(above symbol)



Self-propelled



Half-track



Ski



Sled



Mountain



Railway

*Examples:*



Hq Mtz Inf Div



Mtz Rifle Co



Hq Partly Mtz  
Sig Bn of a  
Mtn Div



Partly Mtz Sig Co  
of an Inf Div



Inf How Co with Towed Wpns



How on SP Mount



Armd (Half-track) Rifle Co



Ski Bn



Ski Co



Mtn Inf How



Bty AA Gun

Gun positions are indicated by the following supplementary symbols:

In Position	In Fixed Position	In Fixed Position under Armor or Concrete	
(above symbol)	(below symbol)	Under construction (below symbol)	Completed (below symbol)

Examples:



AT Gun in Position



Gun in Fixed Position



How in Fixed Position under Armor or Concrete

Various supplementary symbols are employed for the closer characterization of headquarters and units. *Examples:*



Hq of a Comdr of Mtz Sig Int Trs



Maint Co



**47. SUPPLEMENTARY ABBREVIATIONS**

The following supplementary abbreviations are used: *l* or *le* (*leicht*), light; *m* (*mittel*), medium; *s* (*schwer*), heavy; and *sw* (*schwerste*), superheavy. *Examples:*

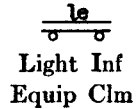
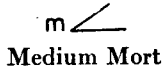

Other supplementary letters are placed to the *left*, to the *right*, *above*, *below*, or *within* the tactical symbol. *Examples:*

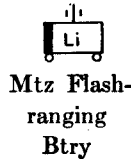
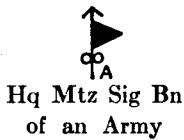

The following supplementary letters are placed to the *right* of the weapon or equipment symbol and indicate the country of origin of such weapon or equipment: *b* (*belgisch*), Belgian; *d* (*dänisch*), Danish; *e* (*englisch*), English; *f* (*französisch*), French; *h* (*holländisch*), Dutch; *j* (*jugoslawisch*), Yugoslav; *n* (*norwegisch*), Norwegian; *ö* (*österreichisch*), Austrian; *p* (*polnisch*), Polish; *r* (*rus-sisch*), Russian; *t* (*tschechisch*), Czech.

**48. SUPPLEMENTARY NUMERALS**

Arabic numerals placed to the *right* of the tactical symbols are employed to identify the number of the following units and their headquarters: armies, divisions, regiments, separate battalions, and companies (or equivalent units). *Example:*



18th Inf Regt

Roman numerals placed to the *right* of the tactical symbols are employed to identify the numbers of the following units and their headquarters: corps, battalions (within regiments), and platoons. *Examples:*

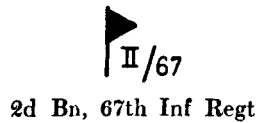

Caliber of weapons is indicated by numerals representing centimeters to the *left* of the weapon symbol. *Example:*

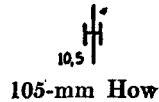

Range of weapons is indicated by numerals representing kilometers *above* the weapon symbol. *Example:*

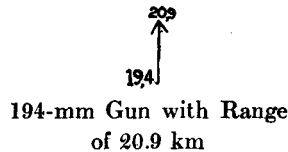

The number of weapons or equipment is indicated by numerals placed *below* the symbol. *Example:*

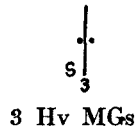

Types of tanks are indicated by Roman numerals *within* the basic tank symbol. *Example:*



The letters *le*, *m*, and *s* are not used with the basic tank symbol to indicate particular types of tanks. They are used, however, to indicate tank units. *Example:*



Light Tk Co

**49. COMPOSITE UNITS**

Should a company consist of several component units, such as headquarters companies and heavy-weapons companies, then the tactical symbols representing the component units are placed *within* the basic company symbol. For simplification, however, the letters *St* (*Stab*) or *S* (*Schwer*) may be substituted. *Examples:*

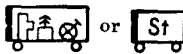

Mtz Hq Co of a Mtz  
Inf Regt

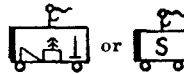

Hv Wpn Co of a Panzer  
Rcn Squadron

**50. EXAMPLE OF A DIAGRAMMATIC TABLE OF ORGANIZATION**

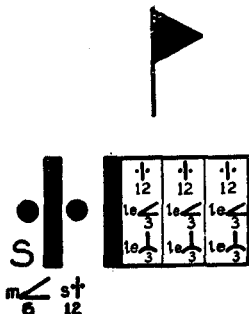

Inf Bn, consisting of—  
 Hq  
 3 Rifle Cos, each with 12 LMGs  
 3 Light Morts, and 3 AT Rifles  
 MG Co with 12 Hv MGs and 6 Medium  
 Morts

**51. SUPERSEDED WEAPON AND EQUIPMENT SYMBOLS**

The following symbols, though superseded, may still be found:

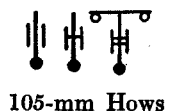
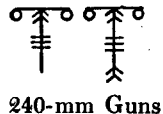
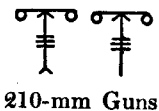
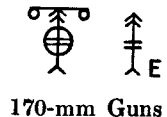
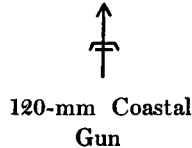
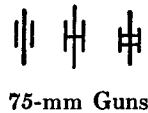
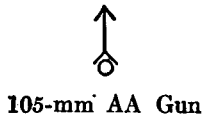
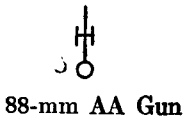
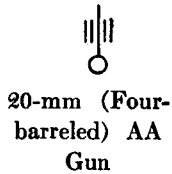
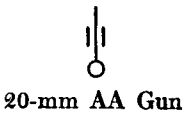
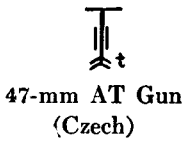
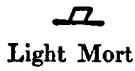



120-mm How



150-mm How

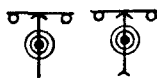

210-mm High-angle  
Hows (Mörser)



240-mm How



305-mm High-angle  
How (Mörser)



420-mm Hows



Tk, M1  
(Pz.Kpfw. I)



Tk, M2  
(Pz.Kpfw. II)



Tk, M3  
(Pz.Kpfw. III)



Tk, M4  
(Pz.Kpfw. IV)



Armd Comd Car



"Volkswagen"  
(Jeep)



Half-track Personnel  
Carrier

**DISTRIBUTION:**

C & H (2) to Continental U. S. and to ETOUSA, NATOUSA, USAFIME, USAFSA, and Caribbean. (For explanation of symbols, see FM 21-6.)